

**D** Montageanleitung.  
Bitte lesen Sie zuerst die Montageanleitung. Technische Änderungen behalten wir uns vor.

**GB** Assembly instructions.  
Please read the instructions first. We reserve the right to change product specifications due to possible technical improvements.

**I** Istruzioni di montaggio.  
Leggere prima le istruzioni. Ci riserviamo il diritto di apportare eventuali modifiche tecniche.

**F** Notice de montage.  
Lisez d'abord la notice de montage. Sous réserves de modifications techniques.

**SIMPLY U** T7221  
T7222

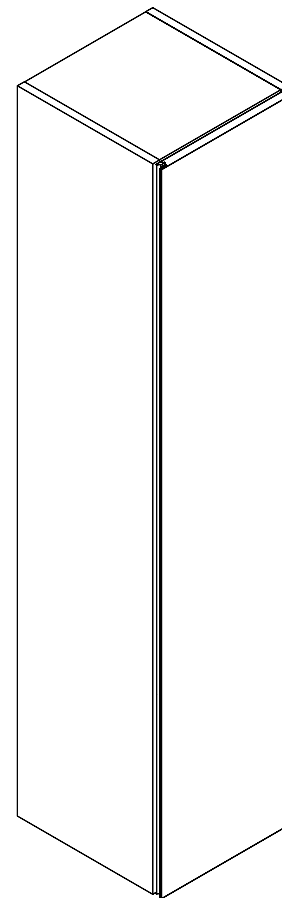
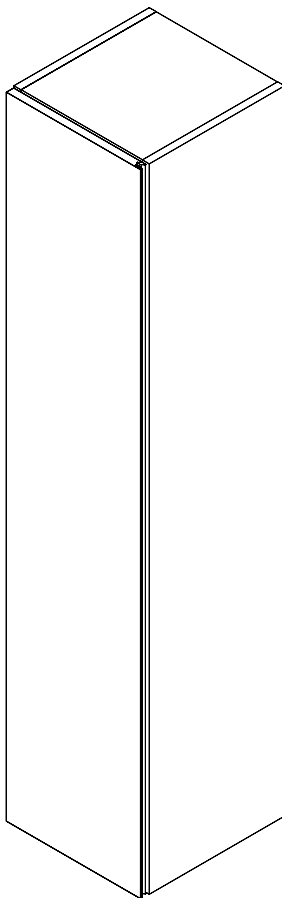

**D** ACHTUNG! Das gelieferte Montagezubehör ist nicht für jede Art von Mauerwerk geeignet. Vor Montage bitte auf Eignung überprüfen.

**GB** WARNING! The supplied mounting hardware is not suitable for all kinds of walls. Please make sure to use the correct mounting hardware for your wall. Seek for qualified advice in case of doubt.

**I** ATTENZIONE! La ferramenta fornita non è adatta a tutti i tipi di muratura. In caso di incertezza prima di procedere all'installazione verificare con un montatore qualificato che il supporto sia adatto.

**F** ATTENTION! Les fixations incluses sont adaptées à un support en béton. Pour tout autre support, utiliser des vis adaptées au matériau. En cas de doute, veuillez vérifier avec un installateur qualifié.

2X

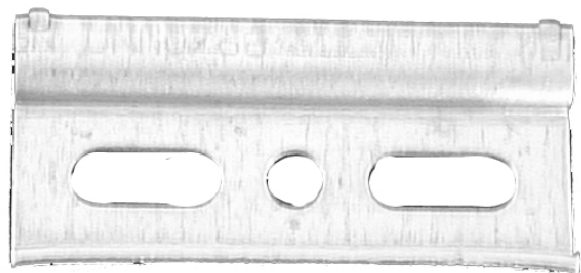

4X



4X



2X

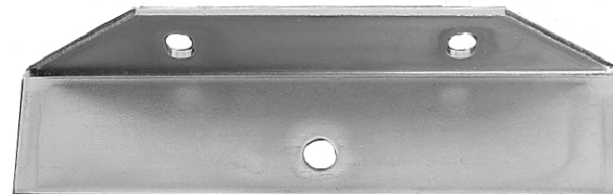

2X



4X



4X

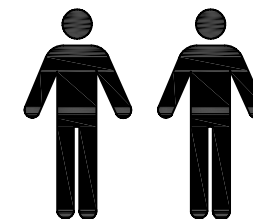

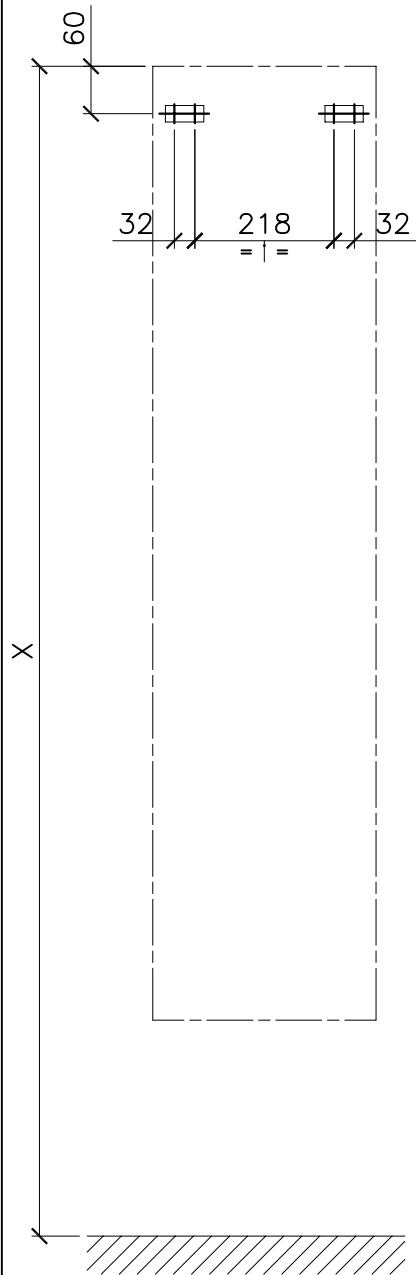
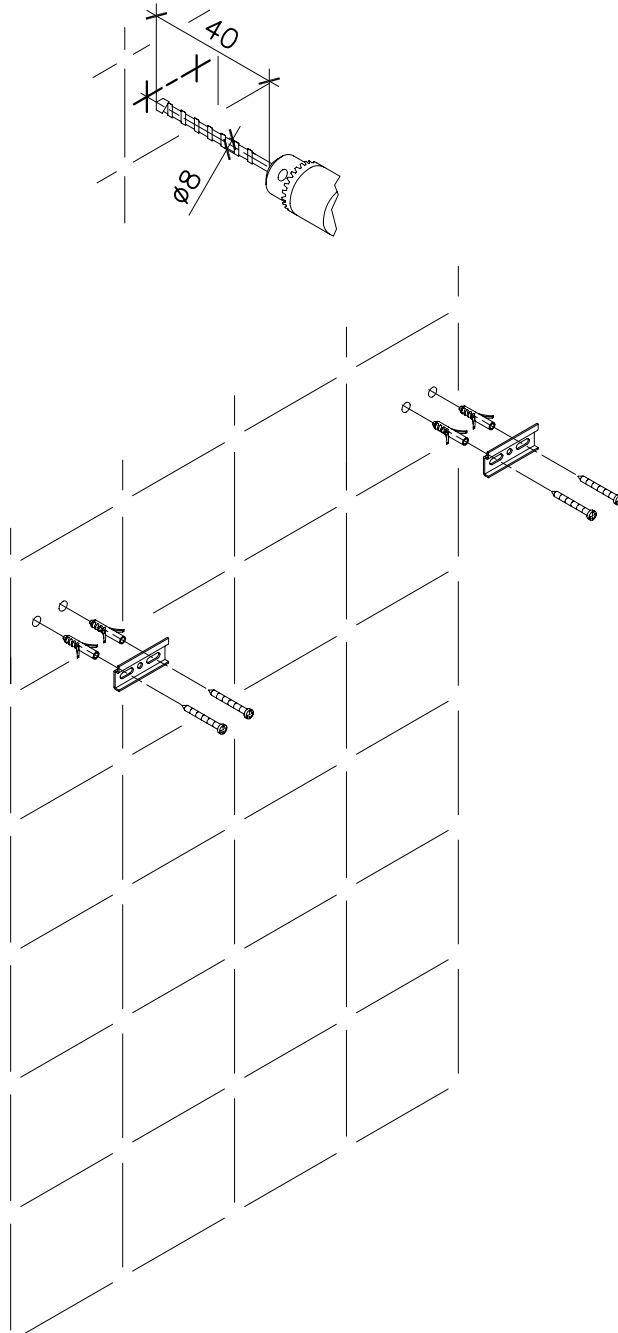
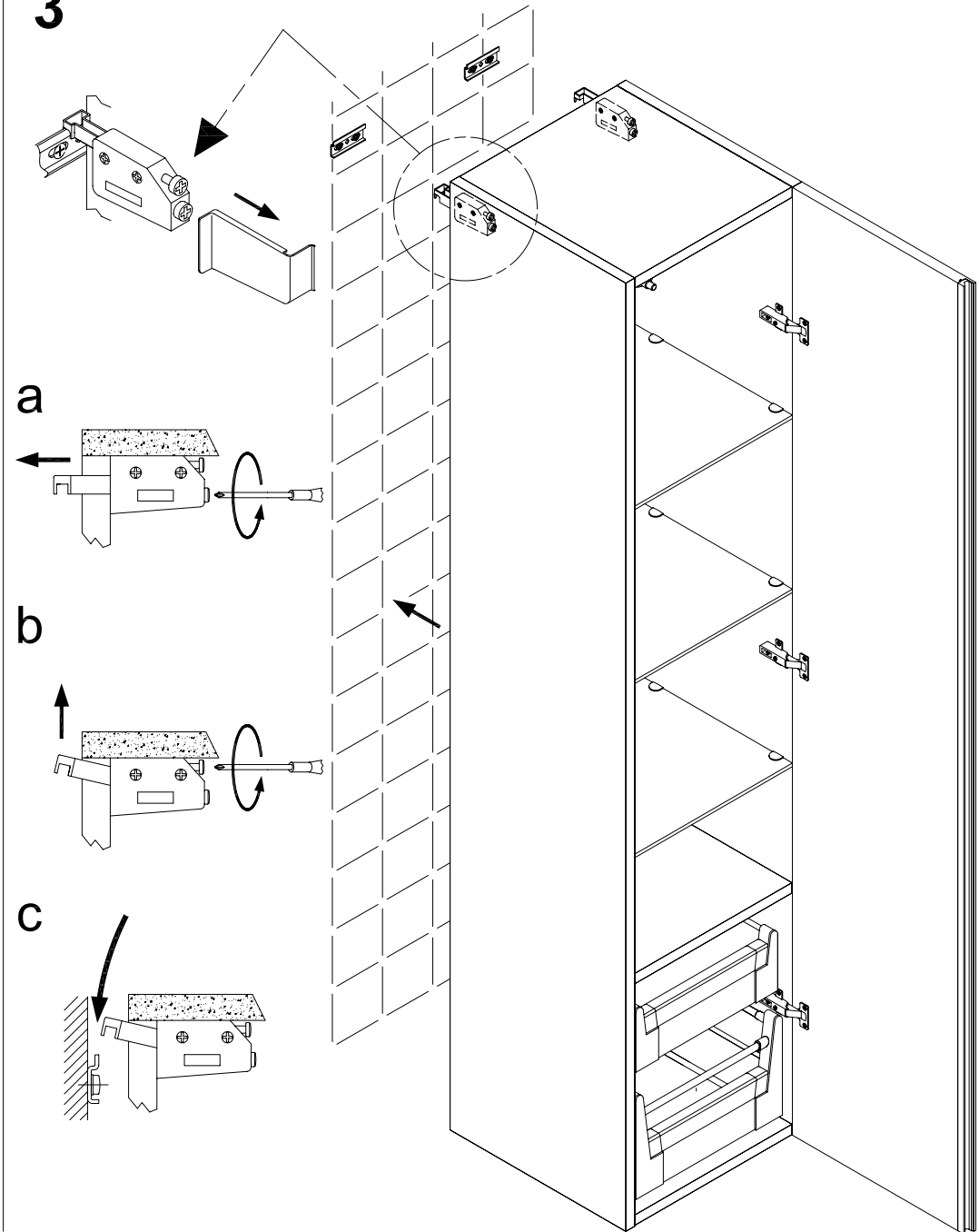
**1****2****3**

4

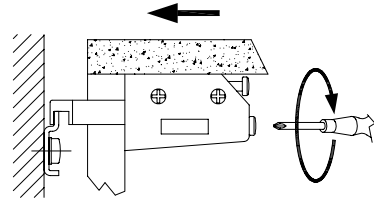
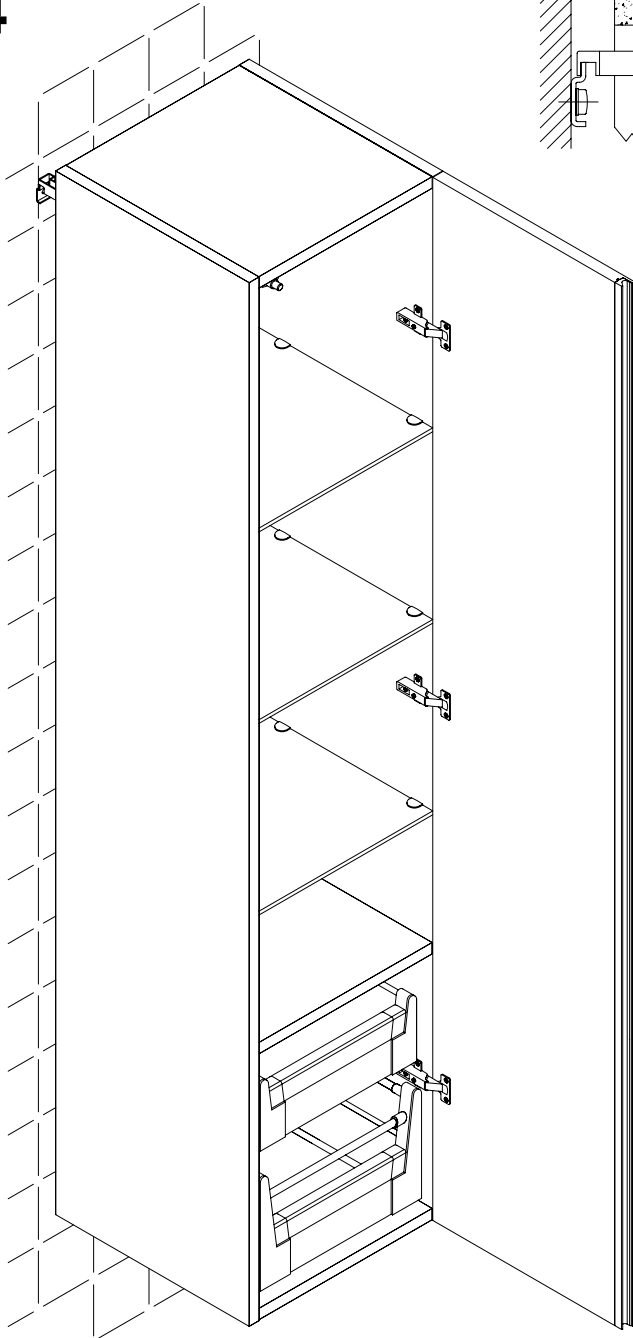

5

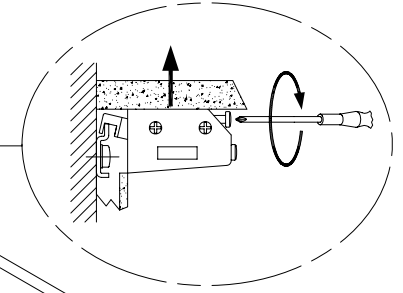
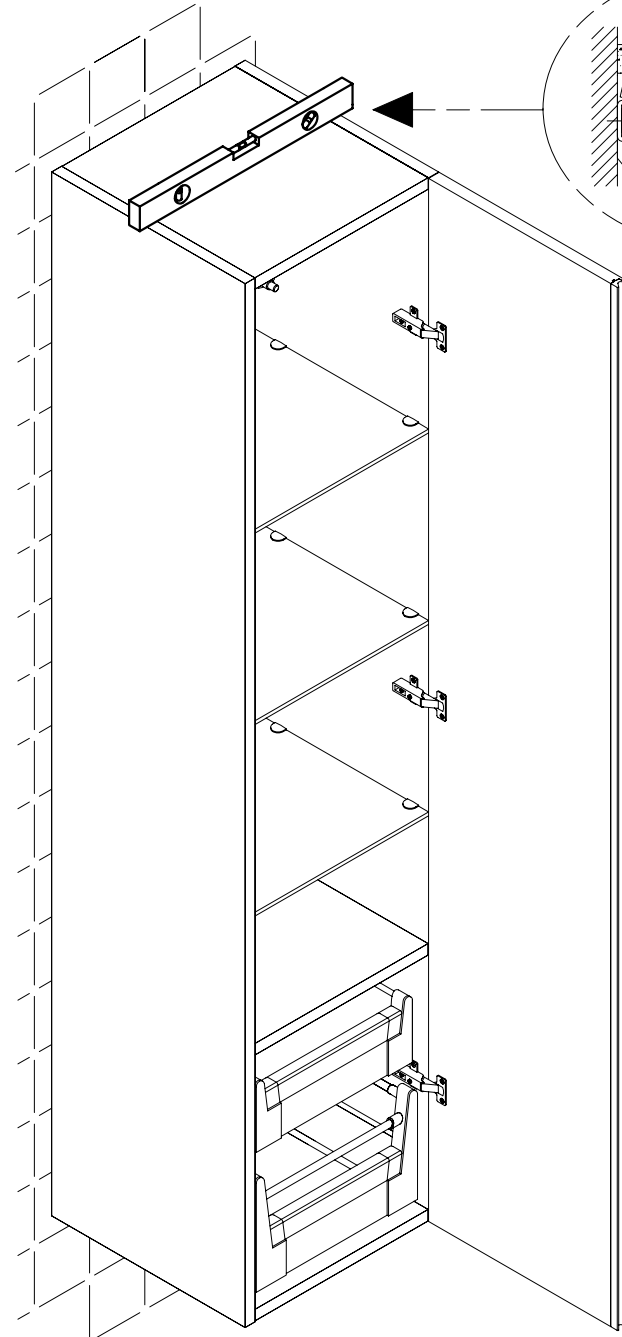

6

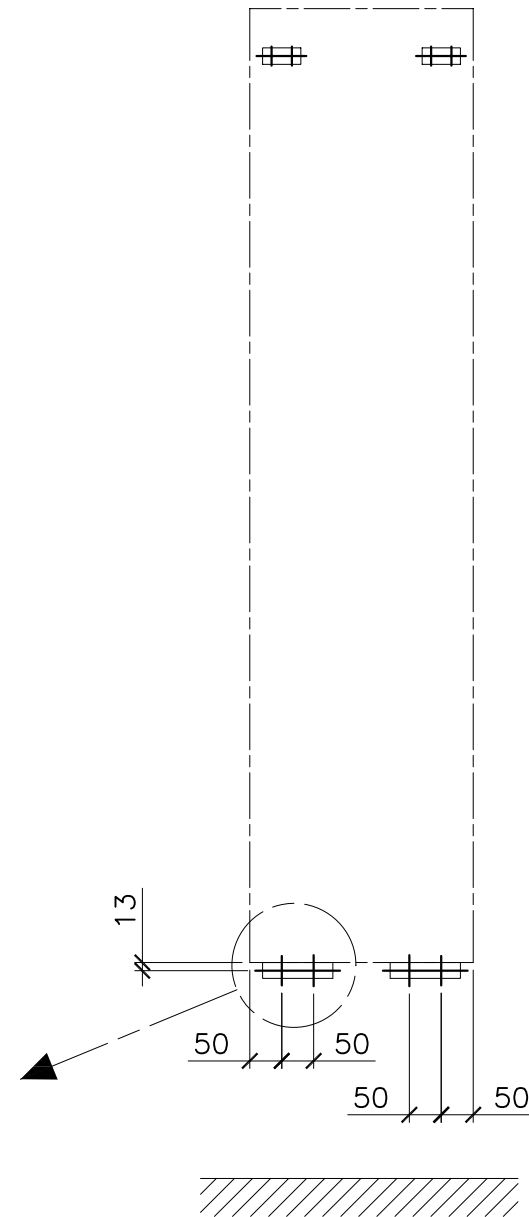
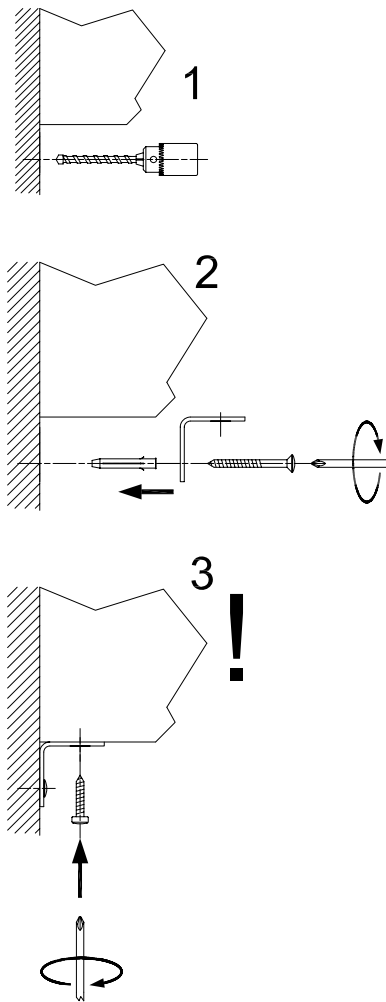
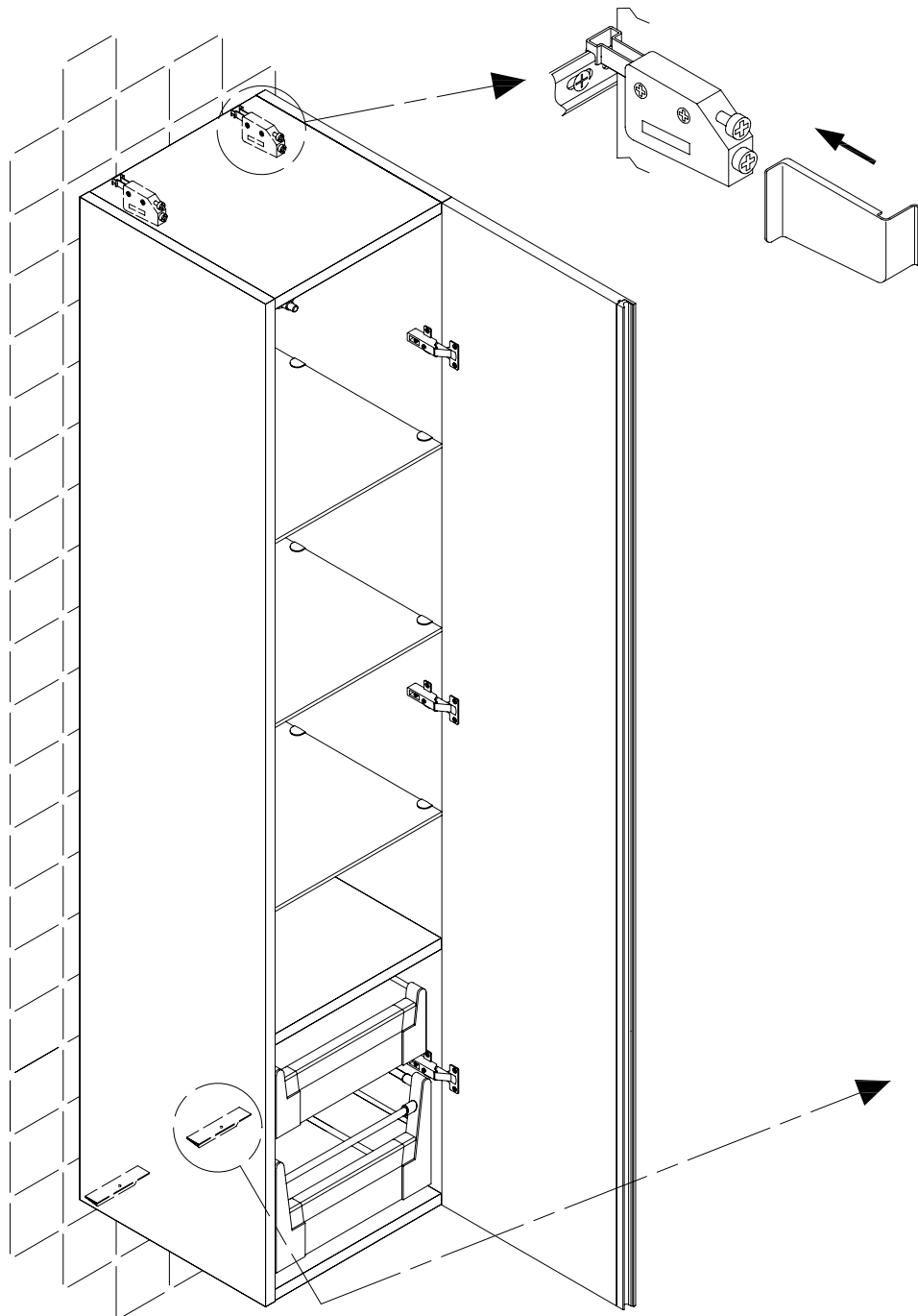

7

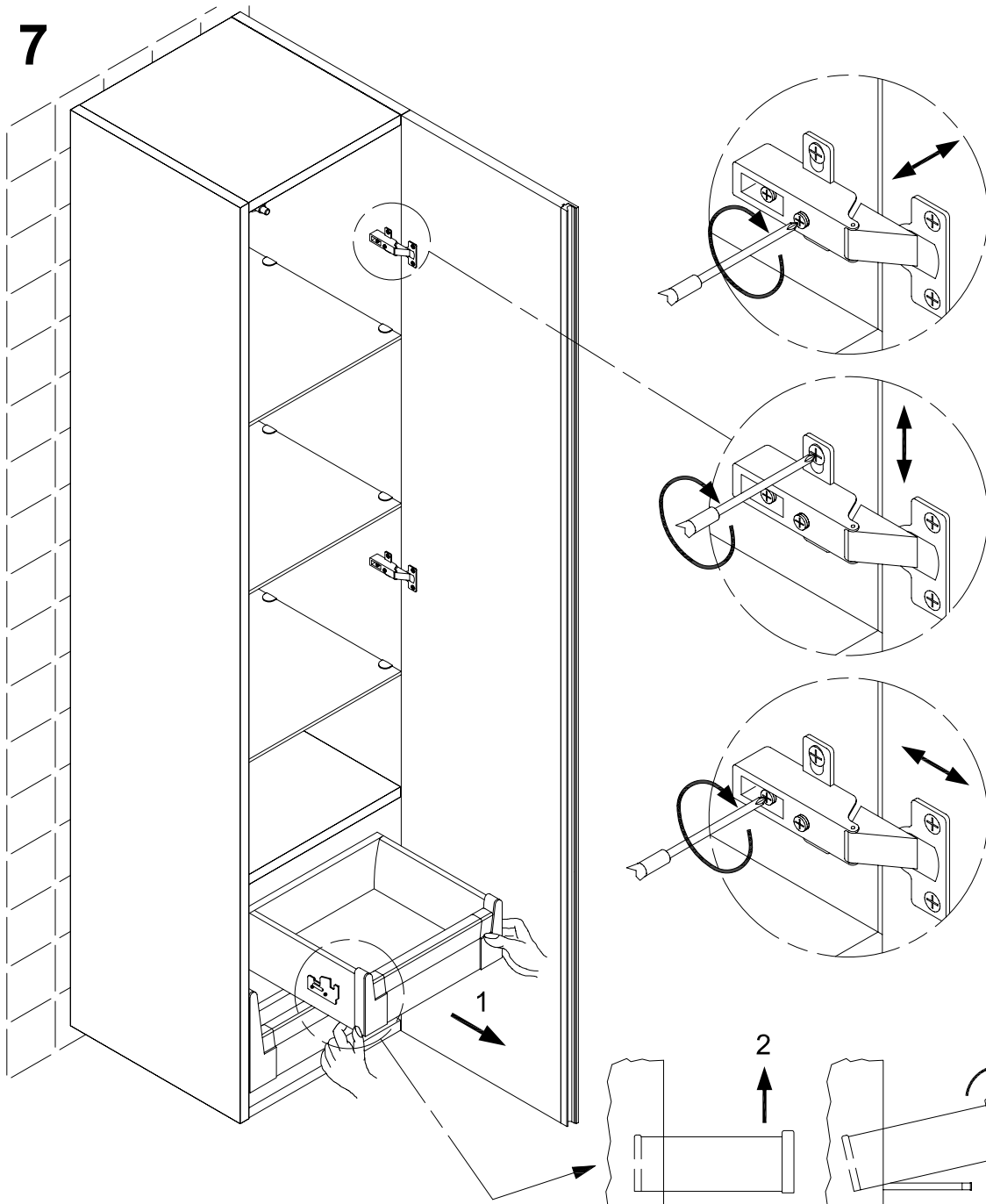

8

