

DE	Gebrauchsanleitung / Montageanleitung	2
FR	Mode d'emploi / Instructions de montage	3
EN	Instructions for use / assembly instructions	4
IT	Istruzioni per l'uso / Istruzioni per Installazione	5
ES	Modo de empleo / Instrucciones de montaje	6
NL	Gebruiksaanwijzing / Handleiding	7
DK	Brugsanvisning / Monteringsvejledning	8
PT	Instruções para uso / Manual de Instalação	9
PL	Instrukcja obsługi / Instrukcja montażu	10
CS	Návod k použití / Montážní návod	11
SK	Návod na použitie / Montážny návod	12
ZH	用户手册 / 组装说明	13
RU	Руководство пользователя / Инструкция по монтажу	14
HU	Használati útmutató / Szerelési útmutató	15
FI	Käyttöohje / Asennusohje	16
SV	Bruksanvisning / Monteringsanvisning	17
LT	Vartotojo instrukcija / Montavimo instrukcijos	18
HR	Upute za uporabu / Uputstva za instalaciju	19
TR	Kullanım kılavuzu / Montaj kılavuzu	20
RO	Manual de utilizare / Instrucțiuni de montare	21
EL	Οδηγίες χρήσης / Οδηγία συναρμολόγησης	22
SL	Navodilo za uporabo / Navodila za montažo	23
ET	Kasutusjuhend / Paigaldusjuhend	24
LV	Lietošanas pamācība / Montāžas instrukcija	25
SR	Uputstvo za upotrebu / Uputstvo za montažu	26
NO	Bruksanvisning / Montasjeveiledning	27
BG	Инструкция за употреба / Инструкция за употреба	28
SQ	Udhëzuesi i përdorimit / Udhëzime rreth montimit	29
AR	دليل الاستخدام / تعليمات التجميع	30

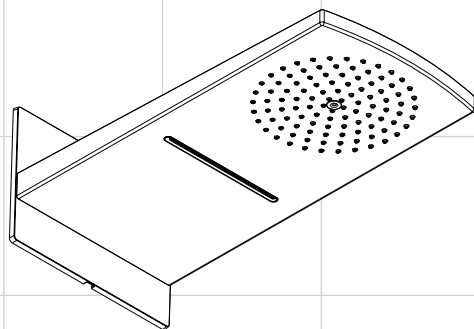

Raindance Rainfall
28433XXX



⚠ Sicherheitshinweise

- ⚠ Bei der Montage müssen zur Vermeidung von Quetsch- und Schnittverletzungen Handschuhe getragen werden.
- ⚠ Der Kopfbrausearm ist nur für das Halten der Kopfbrause ausgelegt, er darf nicht mit weiteren Gegenständen belastet werden!
- ⚠ Kinder, sowie Erwachsene mit körperlichen, geistigen und / oder sensorischen Einschränkungen dürfen nicht unbeaufsichtigt das Duschsystem benutzen. Personen die unter Alkohol- oder Drogeneinfluss stehen, dürfen das Duschsystem nicht benutzen.
- ⚠ Der Kontakt der Brausestrahlen mit empfindlichen Körperstellen (z. B. Augen) muss vermieden werden. Es muss ein ausreichender Abstand zwischen Brause und Körper eingehalten werden.
- ⚠ Das Duschsystem darf nur zur Bade-, Hygiene- und Körperreinigungszwecke eingesetzt werden.
- ⚠ Große Druckunterschiede zwischen den Kalt- und Warmwasseranschlüssen müssen ausgeglichen werden.

Montagehinweise

- Die Leitungen und die Armatur müssen nach den gültigen Normen montiert, gespült und geprüft werden.
- Vor der Montage muss das Produkt auf Transportschäden untersucht werden. Nach dem Einbau werden keine Transport- oder Oberflächenschäden anerkannt.
- Bei der Montage des Produktes durch qualifiziertes Fachpersonal ist darauf zu achten, dass die Befestigungsfläche im gesamten Bereich der Befestigung plan ist (keine vorstehenden Fugen oder Fliesenversatz), der Wandaufbau für eine Montage des Produktes geeignet ist und keine Schwachstellen aufweist.
- Die Schmutzfangsiebe müssen eingebaut werden, um Schmutzeinspülungen aus dem Leitungsnetz zu vermeiden. Schmutzeinspülungen können die Funktion beeinträchtigen und/oder zu Beschädigungen an Funktionsteilen der Armatur führen, für hieraus ergebende Schäden haftet Hansgrohe nicht.
- Dieses Produkt kann nicht in Verbindung mit hydraulisch und thermisch gesteuerten Durchlauferhitzern eingesetzt werden.

Technische Daten

Betriebsdruck:	max. 0,6 MPa
Empfohlener Betriebsdruck: (1 MPa = 10 bar = 147 PSI)	0,2 - 0,4 MPa
Heißwassertemperatur:	max. 60 °C
Empfohlene Heißwassertemperatur:	42 °C
Thermische Desinfektion:	max. 70 °C / 4 min

Symbolerklärung



Kein essigsäurehaltiges Silikon verwenden!



Maße (siehe Seite 31)



Durchflussdiagramm (siehe Seite 32 - 45)



Montagebeispiele (siehe Seite 32 - 45)



Mitte Duschwanne



Warmwasser



Kaltwasser



In diesem Bereich ist eine Wandverstärkung notwendig.



Unterputz-Ventil



Quattro Vierwegeumstellung

Quattro



Trio Universal Absperr- und Umstellventil



Der nicht benötigte Abgang muss mit einem Blindstopfen abgedichtet werden.

> 50 l/min

Die Ablaufleistung muss mehr als 50 l/min betragen.



Ablauf

Raindrain



Reinigung (siehe Seite 49)



Schutzhandschuhe tragen



Augenschutz tragen



Entkalker (zitronensäurebasis)

Augen- und Hautkontakt vermeiden. Falls das Produkt in die Augen gelangt, diese gründlich mit Wasser ausspülen.



Naturschwamm



Serviceteile (siehe Seite 52)





⚠️ Consignes de sécurité

- ⚠️ Lors du montage, porter des gants de protection pour éviter toute blessure par écrasement ou coupure.
- ⚠️ Le bras de la douchette n'est conçu que pour tenir la douchette et ne doit pas servir à la suspension d'autres objets !
- ⚠️ Il est interdit aux enfants ainsi qu'aux adultes ayant des insuffisances physiques, psychiques et/ou motoriques d'utiliser la douche sans surveillance. De même, il est interdit à des personnes sous influence d'alcool ou de drogues d'utiliser la douche.
- ⚠️ Éviter le contact du jet de la douchette avec les parties sensibles du corps (telles par ex. que les yeux). Veiller à respecter un écart suffisant entre la douchette et le corps
- ⚠️ Le système de douche ne doit servir qu'à se laver et à assurer l'hygiène corporelle.
- ⚠️ Il est conseillé d'équilibrer les pressions de l'eau chaude et froide.

Instructions pour le montage

- Les conduites et la robinetterie doivent être montés, rincés et contrôlés selon les normes en vigueur.
- Avant son montage, s'assurer que le produit n'a subi aucun dommage pendant le transport. Après le montage, tout dommage de transport ou de surface ne pourra pas être reconnu.
- Lors du montage de ce produit par du personnel qualifié, veiller à ce que la surface de fixation soit bien plane dans toute la zone de fixation (pas de dépassement de joints ou de déport de carreaux), à ce que le mur se prête au montage du produit et ne présente aucun point fragile.
- Les tamis doivent être mis en place pour éviter aux saletés de s'infiltrer dans le réseau de conduites. Les saletés peuvent porter préjudice au fonctionnement et/ou provoquer des endommagements au niveau des éléments fonctionnels de la robinetterie. En cas de dommages en résultant, la responsabilité de Hansgrohe ne pourra pas être mise en cause.
- Les mitigeurs Hansgrohe ne doivent pas être utilisés avec des chauffe-eau instantané à commande hydraulique ou thermique.

Informations techniques

Pression de service autorisée:	max. 0,6 MPa
Pression de service conseillée:	0,2 - 0,4 MPa
(1 MPa = 10 bar = 147 PSI)	
Température d'eau chaude:	max. 60°C
Température recommandée:	42°C
Désinfection thermique:	max. 70°C / 4 min

Description du symbole



Ne pas utiliser de silicone contenant de l'acide acétique!



Dimensions (voir page 31)



Diagramme du débit (voir page 32 - 45)



Exemples de montage (voir pages 32 - 45)



Centre cuvette de douche



Eau chaude



Eau froide



Le mur n'a pas besoin d'être renforcé à cet endroit



Robinet d'arrêt encastré



Quattro inverseur quatre voies

Quattro



Trio Robinet d'arrêt avec inverseur



Trio



> 50 l/min

La sortie non utilisée doit être condamnée avec un bouchon laiton.



Vidage

Raindrain



Nettoyage (voir page 49)



Protection obligatoire des mains



Protection obligatoire de la vue



Détartrant (À base d'acide citrique)

Éviter tout contact avec les yeux et la peau. Si le produit saute aux yeux, rincer ces derniers à l'eau abondante



éponge naturelle



Pièces détachées (voir pages 52)





⚠ Safety Notes

- ⚠ Gloves should be worn during installation to prevent crushing and cutting injuries.
- ⚠ The arm of the shower head is intended only to hold the shower head. Do not load it down with other objects!
- ⚠ Children as well as adults with physical, mental and/or sensoric impairments must not use this shower system without proper supervision. Persons under the influence of alcohol or drugs are prohibited from using this shower system.
- ⚠ Do not allow the streams of the shower touch sensitive body parts (such as your eyes). An adequate distance must be kept between the shower and you.
- ⚠ The shower system may only be used for bathing, hygienic and body cleansing purposes.
- ⚠ The hot and cold supplies must be of equal pressures.

Installation Instructions

- The pipes and the fixture must be installed, flushed and tested as per the applicable standards.
- Prior to installation, inspect the product for transport damages. After it has been installed, no transport or surface damage will be honoured.
- During installation of the product by qualified trained personnel, make sure that the entire fastening surface is even and smooth (no protruding seams or tile offset), that the finish of the wall is suitable to apply the product and has no weak points.
- The mesh washers must be installed to protect against incoming dirt by pipework. Incoming dirt can impair the function and/or lead to damages on functional parts of the fixture; Hansgrohe will not be held liable for resulting damages.
- This mixer cannot be used in conjunction with hydraulically, electronically or thermally controlled instantaneous heaters.

Technical Data

Operating pressure:	max. 0,6 MPa
Recommended operating pressure: (1 MPa = 10 bar = 147 PSI)	0,2 - 0,4 MPa
Hot water temperature:	max. 60 °C
Recommended hot water temp.:	42 °C
Thermal disinfection:	max. 70 °C / 4 min

Symbol description



Do not use silicone containing acetic acid!



Dimensions (see page 31)



Flow diagram (see page 32 - 45)



Installation example (see page 32 - 45)



Center shower tub



Warm water



Cold water



The wall must be reinforced in this area.



Shut off valve



Quattro 4-Way Diverter Valve

Quattro



Trio 2-Way Diverter Valve with integrated Shut-off valve

Trio



Plug the unused outlet.



The waste drain performance must be more than 50 l/min.

> 50 l/min



Waste

Raindrain



Cleaning (see page 49)



Safety gloves must be worn



Eye protection must be worn



Decalcifier (Citric acid base)

Avoid contact with eyes and skin. If this product contacts your eyes, rinse thoroughly with water.



natural sponge



Spare parts (see page 52)





⚠ Indicazioni sulla sicurezza

- ⚠ Durante il montaggio, per evitare ferite da schiacciamento e da taglio bisogna indossare guanti protettivi.
- ⚠ Il braccio del soffione della doccia è progettato per sostenere solo quest'ultimo, non va sovraccaricato con altri oggetti!
- ⚠ I bambini e gli adulti affetti da menomazioni fisiche, psichiche e/osenso-riali devono utilizzare il sistema della doccia solo sotto la supervisione di una persona responsabile.
- ⚠ Bisogna evitare il contatto fra il getto della doccia e parti del corpo delicate (ad es. gli occhi). Fra il soffione ed il corpo va mantenuta una distanza sufficiente.
- ⚠ Il sistema doccia deve essere utilizzato esclusivamente per l'igiene del corpo.
- ⚠ Attenzione! Compensare le differenze di pressione tra i collegamenti dell'acqua fredda e dell'acqua calda.

Istruzioni per il montaggio

- Montare, lavare e controllare tubature e rubinetteria rispettando le norme correnti.
- Prima del montaggio è necessario controllare che non ci siano stati danni durante il trasporto. Una volta eseguito il montaggio, non verranno riconosciuti eventuali danni di trasporto o delle superfici.
- Per il montaggio del prodotto da personale specializzato qualificato bisogna fare attenzione, che la superficie di fissaggio, in tutto il campo di fissaggio, sia piana (nessuna giunzione sporgente o sfalsamento di piastrella), la costruzione della parete sia adatta al montaggio del prodotto e che non presenti alcun punto debole.
- E' necessario montare i filtri per la raccolta della sporcizia per evitare che eventuali impurità provenienti dalla rete delle tubazioni causino danni. Queste possono infatti compromettere le funzioni e/o causare danni a parti funzionali della rubinetteria. La Hansgrohe non risponde di danni da ciò causati.
- I miscelatori non sono compatibili con le caldaie istantanee.

Dati tecnici

Pressione d'uso:	max. 0,6 MPa
Pressione d'uso consigliata:	0,2 - 0,4 MPa
(1 MPa = 10 bar = 147 PSI)	
Temperatura dell'acqua calda:	max. 60°C
Temp. dell'acqua calda consigliata:	42°C
Disinfezione termica:	max. 70°C / 4 min

Descrizione simbolo



Non utilizzare silicone contenente acido acetico!



Ingombri (vedi pagg. 31)



Diagramma flusso (vedi pagg. 32 - 45)



Esempio di installazione (vedi pagg. 32 - 45)



Centro piatto doccia



Acqua calda



Acqua fredda



In questa zona è necessario un rinforzo della parete.



Rubinetto di arresto



Quattro Valvola a quattro vie

Quattro



Trio arresto/deviatore



Chiudere con un tappo l'uscita non utilizzata.



La portata di scarico deve essere superiore a 50 l/min.

> 50 l/min



Scarico



Pulitura (vedi pagg. 49)



Indossare guanti di protezione



Indossare la protezione per gli occhi



Decalcificatore (a base di acido citrico)

Evitare il contatto con gli occhi e la pelle. Nel caso il prodotto penetra negli occhi, sciacquarlo accuratamente con acqua.



spugna naturale



Parti di ricambio (vedi pagg. 52)





Indicaciones de seguridad

- ⚠ Durante el montaje deben utilizarse guantes para evitar heridas por aplastamiento o corte.
- ⚠ El brazo del pulverizador de ducha solo está previsto para soportar el pulverizador de ducha !no debe cargarse con otros objetos!
- ⚠ Niños, así como adultos con limitaciones corporales, mentales y/o sensoriales no deben utilizar el sistema de duchas sin vigilancia. Personas que se encuentran bajo el efecto de alcohol o drogas, no deben utilizar el sistema de duchas.
- ⚠ Debe evitarse el contacto del chorro del pulverizador con partes sensibles del cuerpo (por ej. ojos). Debe mantenerse una distancia suficiente entre pulverizador y cuerpo.
- ⚠ El sistema de ducha solo debe ser utilizado para fines de baño, higiene y limpieza corporal.
- ⚠ Grandes diferencias de presión en servicio entre agua fría y agua caliente deben equilibrarse.

Indicaciones para el montaje

- Los conductos y la grifería deben montarse, lavarse y comprobarse según las normas vigentes.
- Antes del montaje se debe examinar el producto contra daños de transporte. Después de la instalación se reconoce ningún daño de transporte o de superficie.
- Durante el montaje del producto, mediante personal especializado, se debe asegurar de que la superficie de sujeción en todo el área de la fijación sea plana (sin fugas o azulejos que sobresalgan), que la estructura del muro sea adecuada para el montaje del producto y que no presente puntos débiles.
- Los tamices recogelodos deben ser instalados para evitar las partículas de suciedad procedentes de las tuberías. Infiltraciones de suciedad pueden deteriorar el funcionamiento y/o pueden causar daños en los componentes de las válvulas que no están cubiertos por la garantía de Hansgrohe.
- Los mezcladores no pueden usarse con calentadores instantáneos mandados hidráulicamente o térmicamente.

Datos técnicos

Presión en servicio:	max. 0,6 MPa
Presión recomendada en servicio: (1 MPa = 10 bar = 147 PSI)	0,2 - 0,4 MPa
Temperatura del agua caliente:	max. 60 °C
Temp. recomendada del agua caliente:	42 °C
Desinfección térmica:	max. 70 °C / 4 min

Descripción de símbolos



No utilizar silicona que contiene ácido acético!



Dimensiones (ver página 31)



Diagrama de circulación (ver página 32 - 45)



Ejemplos de montaje (ver página 32 - 45)



Centro la plato de ducha



Agua caliente



Agua fría



En este sector es necesario un refuerzo del muro.



Llave de paso



Quattro válvula de 4 vías

Quattro



Trio llave de paso y distribuidor



El caudal de desagüe debe ser como mínimo de 50 l/min

> 50 l/min

Desagüe



Raindrain



Limpiar (ver página 49)



Protección obligatoria de la vista



Protección obligatoria de las manos



Descalcificador (a base de ácido cítrico)

Evitar el contacto con ojos y piel. En caso de que el producto entre en contacto con los ojos, debe lavarlos muy bien con agua.
Esponja natural



Repuestos (ver página 52)





⚠ Veiligheidsinstructies

- ⚠ Bij de montage moeten ter voorkoming van knel- en snijwonden handschoenen worden gedragen.
- ⚠ De arm van de hoofddouche is uitsluitend voor het vasthouden van de hoofddouche bedoeld en mag niet met verdere voorwerpen worden belast!
- ⚠ Kinderen en volwassenen met lichamelijke, geestelijke en/of sensorische beperkingen mogen het douchesysteem niet zonder toezicht gebruiken. Personen onder invloed van alcohol of drugs mogen het douchesysteem niet gebruiken.
- ⚠ Het contact van de douchestraal met gevoelige lichaamsdelen (bijv. ogen) moet worden voorkomen. Er moet voldoende afstand tussen douche en lichaam aangehouden worden.
- ⚠ Het douchesysteem mag alleen voor het wassen, hygiënische doeleinden en voor de lichaamreiniging worden gebruikt.
- ⚠ Grote drukverschillen tussen de kouden warm wateraansluitingen dienen vermeden te worden.

Montage-instructies

- De leidingen en armaturen moeten gemonteerd, gespoeld en gecontroleerd worden volgens de geldige normen.
- Vóór de montage moet het product gecontroleerd worden op transport-schade. Na de inbouw wordt geen transport- of oppervlakteschade meer aanvaard.
- Bij de montage van het product door gekwalificeerd vakpersoneel moet erop gelet worden dat het montagevlak in het volledige bereik van de bevestiging vlak is (geen uitstekende voegen of verspringende tegels), dat de wand geschikt is voor de montage van het product en geen zwakke plaatsen vertoont.
- De vuilzeefjes moeten ingebouwd worden om te vermijden dat vuil uit het leidingwater meekomt. Vuil uit de leidingen kan de werking negatief beïnvloeden en/of de armatuur beschadigen. Voor daaruit resulterende schade is Hansgrohe niet aansprakelijk.
- Hansgrohe kranen mogen niet in verbinding met hydraulische en thermisch gestuurde geisers geplaatst worden.

Technische gegevens

Werkdruk: max.	max. 0,6 MPa
Aanbevolen werkdruk:	0,2 - 0,4 MPa
(1 MPa = 10 bar = 147 PSI)	
Temperatuur warm water:	max. 60°C
Aanbevolen warm water temp.:	42°C
Thermische desinfectie:	max. 70°C / 4 min

Symboolbeschrijving



Gebruik geen zuurhoudende silicone!



Maten (zie blz. 31)



Doorstroombiagram (zie blz. 32 - 45)



Montagevoorbeelden (zie blz. 32 - 45)



Midden Douchebak



Warm water



Koud water



In dit bereik is een wandversterking noodzakelijk.



Inbouwstopkraan



Quattro 4-weg omstelkraan

Quattro



Trio stop- en omstelkraan



Trio

De niet benodigde uitgang moet met een blindstop worden afgedicht.



De afvoercapaciteit moet meer dan 50 l/min bedragen.

> 50 l/min

Afvoer



Raindrain



Reinigen (zie blz. 49)



Veiligheidshandschoenen verplicht



Oogbescherming verplicht



Ontkalker (citroenzuurbasis)

Contact met huid en ogen vermijden. Indien het product in de ogen terecht komt, moet het grondig met water uitgespoeld worden.



Natuurzwam



Service onderdelen (zie blz. 52)





⚠ Sikkerhedsanvisninger

- ⚠ Ved monteringen skal der bruges handsker for at undgå kvæstelser og snitsår.
- ⚠ Stangen til hovedbruseren er kun beregnet til at holde hovedbruseren. Den må ikke belastes med andre genstande!
- ⚠ Børn som også voksne med fysiske, mentale og / eller sensoriske begrænsninger må ikke bruge brusersystemet uden opsyn. Personer som er under indflydelse af alkohol eller narkotika må ikke bruge brusersystemet.
- ⚠ Bruserstrålens kontakt med sensitive områder (f.eks. øjne) skal undgås. Der skal være en tilstrækkelig afstand mellem bruseren og kroppen.
- ⚠ Brusersystemet må kun bruges til bade-, hygiejne og rengøringsformål.
- ⚠ Større trykforskelle mellem koldt og varmt vand bør udjævnes.

Monteringsanvisninger

- Ledningerne og armaturerne skal monteres, skylles og kontrolleres iht. de gældende standarder.
- Før monteringen skal produktet kontrolleres for transportskader. Efter monteringen godkendes transportskader eller skader på overfladen ikke længere.
- Ved montering af produktet igennem kvalificerede fagfolk skal der holdes øje med, at fastgørelsesoverfladen er plan i alle områder hvor produktet monteres (ingen fremragende fuger eller fliseforskydninger), at væggene er velegnet til monteringen af produktet og ikke har svare områder.
- Smudsfangssierne skal sættes i for at undgå snavs fra rørsystemet. Tilsmudsningen kan påvirke funktionen og/eller føre til skader på armaturets funktionskomponenter. Hansgrohe er ikke ansvarligt for heraf resulterende skader.
- Hansgrohe armaturer kan ikke anvendes i forbindelse med hydraulisk og termisk styrede vandvarmere.

Tekniske data

Driftstryk:	max. 0,6 MPa
Anbefalet driftstryk: (1 MPa = 10 bar = 147 PSI)	0,2 – 0,4 MPa
Varmtvandstemperatur:	max. 60 °C
Anbefalet varmtvandstemperatur:	42 °C
Termisk desinfektion:	max. 70 °C / 4 min

Symbolbeskrivelse



Der må ikke benyttes eddikesyreholdig silikone!



Målene (se s. 31)



Gennemstrømningsdiagram (se s. 32 - 45)



Monteringseksempler (se s. 32 - 45)



Midt brusekar



Varmt vand



Kold vand



I dette område er en forstærkning af væggen nødvendig.



Afspæringsventil



Quattro 4-veg omstelkraan

Quattro



Trio afspæringsventil og omskifter



Trio



Afgangen, der ikke benyttes, skal afproppes.



Afløbskapaciteten skal være mere end 50 l/min.

> 50 l/min

Afløb



Raindrain



Rengøring (se s. 49)



Beskyttelseshandsker påbudt



Øjenværn påbudt



Afkalkningsmiddel (citronsyrebasis)

Undgå kontakt med øjne og huden. Skyl grundigt med vand, hvis produktet kommer i øjnene.



Natursvamp



Reserve dele (se s. 52)





⚠ Avisos de segurança

- ⚠ Durante a montagem devem ser utilizadas luvas de protecção, de modo a evitar ferimentos resultantes de entalamentos e de cortes.
- ⚠ O braço do chuveiro foi concebido apenas para servir de apoio à cabeça do chuveiro, pelo que não pode ser sujeito a cargas de objectos adicionais!
- ⚠ Crianças e adultos com deficiências motoras, mentais e/ou sensoriais não podem utilizar o sistema de duche sem monitorização. Pessoas que estejam sob a influência de álcool ou drogas não podem utilizar o sistema de duche.
- ⚠ Deve-se evitar o contacto dos jactos de água com partes do corpo sensíveis (p. ex. olhos). É necessário manter uma distância suficiente entre o chuveiro e o corpo.
- ⚠ O sistema de duche só pode ser utilizado para fins de higiene pessoal.
- ⚠ Grandes diferenças entre as pressões das águas quente e fria devem ser compensadas.

Avisos de montagem

- As tubagens e a torneira têm que ser montadas, enxaguadas e verificadas de acordo com as normas em vigor.
- Antes da montagem deve-se controlar o produto relativamente a danos de transporte. Após a montagem não são aceites quaisquer danos de transporte ou de superfície.
- Durante a montagem efectuada por técnicos qualificados deve ter-se em atenção que a superfície de fixação seja plana em toda a sua extensão (sem juntas ou ladrilhos salientes), que a estrutura da parede seja adequada para a montagem do produto e que não apresente pontos fracos.
- Os colectores de sujidade/impurezas têm que ser montados, de modo a evitar o enxaguamento de sujidade proveniente da rede de água. A sujidade proveniente da rede pode influenciar o funcionamento e/ou provocar danos nas peças funcionais do equipamento. A Hansgrohe não se responsabiliza por danos daí resultantes.
- As misturadoras não são compatíveis com o uso de esquentadores instantâneos hidráulicos, electrónicos ou térmicos.

Dados Técnicos

Pressão de funcionamento:	max. 0,6 MPa
Pressão de func. recomendada:	0,2 - 0,4 MPa
(1 MPa = 10 bar = 147 PSI)	
Temperatura da água quente:	max. 60 °C
Temp. água quente recomendada:	42 °C
Desinfecção térmica:	max. 70 °C / 4 min

Descrição do símbolo



Não utilizar silicone que contenha ácido acético!



Medidas (ver página 31)



Fluxograma (ver página 32 - 45)



Exemplos de montagem (ver página 32 - 45)



Meio da base de duche



Água quente



Água fria



Nesta zona é necessário um reforço na parede.



Torneira de passagem



Quatro válvula de diversão de 4 vias

Quattro



Trio universal inversor/válvula de corte

Trio



Tamponar a saída não utilizada.



Capacidade de escoamento tem que ser superior a 50 l/min.

> 50 l/min

Escoamento



Raindrain



Limpeza (ver página 49)



Protecção obrigatória das mãos



Protecção obrigatória dos olhos



Descalcificador (À base de ácido cítrico)

Evitar contacto com os olhos e pele. Se o produto entrar em contacto com os olhos deve lavar abundantemente com água.
Esponja natural



Peças de substituição (ver página 52)





⚠ Wskazówki bezpieczeństwa

- ⚠ Aby uniknąć zranień, takich jak zgniecenia czy przecięcia, podczas montażu należy nosić rękawice.
- ⚠ Ramię prysznica jest przystosowane do trzymania głowicy prysznica i nie może być obciążane innymi przedmiotami!
- ⚠ Zarówno dzieci, jak i dorośli z fizycznymi, psychicznymi i/lub sensorycznymi ograniczeniami nie mogą korzystać z prysznica bez opieki. Osoby znajdujące się pod wpływem alkoholu lub narkotyków nie mogą korzystać z prysznica.
- ⚠ Należy unikać kontaktu strumienia wypływającego z głowicy z wrażliwymi częściami ciała (np. oczami). Należy zachowywać odpowiednią odległość pomiędzy głowicą a ciałem.
- ⚠ Pysznic może być używany tylko w celach kąpieli, higieny i utrzymania czystości ciała.
- ⚠ Znaczne różnice ciśnień na dopływach ciepłej i zimnej wody muszą zostać wyrównane.

Wskazówki montażowe

- Przewody i armatura muszą być montowane, płukane i kontrolowane według obowiązujących norm.
- Przed montażem należy skontrolować produkt pod kątem szkód transportowych. Po montażu nie widać żadnych szkód transportowych ani szkód na powierzchni.
- Przy montażu produktu przez wykwalifikowany personel fachowy należy zważyć na to, by powierzchnia mocowania na całym obszarze mocowania była równa (by nie było szczelin wzgl. wzajemnie przesuniętych płytek), rodzaj ściany nadawał się do montażu produktu i zwłaszcza, by nie było żadnych słabych miejsc.
- Należy zamontować sitka łapaczy, aby zatrzymać zanieczyszczenia przedostające się z sieci instalacyjnej. Przedostające się zanieczyszczenia mogą mieć negatywny wpływ na działanie i/lub prowadzić do usterek w działaniu akcesoriów; za powstałe z tego tytułu szkody firma Hansgrohe nie ponosi odpowiedzialności.
- Armatura Hansgrohe może być wykorzystywana w połączeniu z hydraulicznie, elektronicznie i termicznie sterowanym ogrzewaczem przepływowym.

Dane techniczne

Ciśnienie robocze:	maks. 0,6 MPa
Zalecane ciśnienie robocze: (1 MPa = 10 bary = 147 PSI)	0,2 - 0,4 MPa
Temperatura wody gorącej:	maks. 60 °C
Zalecana temperatura wody gorącej:	42 °C
Dezynfekcja termiczna:	maks. 70 °C / 4 min

Opis symbolu



Nie stosować silikonów zawierających kwas octowy!



Wymiary (patrz strona 31)



Schemat przepływu (patrz strona 32 - 45)



Przykłady montażowe (patrz strona 32 - 45)



Środek brodzika



Ciepła woda



Zimna woda



W tym obszarze konieczne jest wzmocnienie ściany.



Zawór podtynkowy



Regulator czterodrożny Quattro

Quattro



Zawór odcinający i regulacyjny Trio Universal



Niewykorzystany wylot należy zakorkować dołożonym w dostawie korkiem.

> 50 l/min

Wydajność odpływu musi być wyższa niż 50 l/min.



Odpływ

Raindrain



Czyszczenie (patrz strona 49)



Nosić rękawice ochronne



Nosić okulary ochronne



Środek odkamieniający (na bazie kwasu cytrynowego)

Unikać kontaktu z oczami i skórą. Jeżeli produkt dostanie się do oczu, należy je gruntownie wypłukać wodą.
Gąbka naturalna



Części serwisowe (patrz strona 52)





⚠ Bezpečnostní pokyny

- ⚠ Pro zabránění řezným zraněním a pohmožděninám je nutné při montáži nosit rukavice.
- ⚠ Držák sprchové hlavice je dimenzován pouze pro držení sprchové hlavice a nesmí se zatěžovat dalšími předměty!
- ⚠ Děti a dospělé osoby s tělesným, duševním a / nebo smyslovým postižením nesmí sprchový systém používat bez dozoru. Osoby pod vlivem alkoholu nebo drog nesmí sprchový systém používat.
- ⚠ Je nutné zabránit kontaktu vodních paprsků sprchy s měkkými částmi těla (např. očima). Je nutné dodržovat dostatečný odstup mezi sprchou a tělem.
- ⚠ Sprchový systém smí být používán pouze ke koupání a za účelem tělesné hygieny.
- ⚠ Je nutné vyrovnat velké rozdíly tlaku mezi přípoji studené a teplé vody.

Pokyny k montáži

- Vedení a armatura musí být namontovány, propláchnuty a otestovány podle platných norem.
- Před montáží je třeba produkt zkontrolovat, zda nebyl při transportu poškozen. Po zabudování nebudou uznány žádné škody způsobené transportem nebo poškození povrchu.
- Při montáži produktu kvalifikovanou osobou je třeba dbát na to, aby byla upevňovací plocha v celé oblasti upevnění rovná (žádné vyčnívající spáry nebo zapuštění obkladů), aby struktura stěny byla vhodná pro montáž produktu a neměla žádná slabá místa.
- Síťka na zachytávání nečistot je třeba zabudovat, aby se zabránilo nečistotám vyplaveným z vodovodní sítě. Vyplavené nečistoty mohou ovlivnit funkci sprchy a / nebo mohou vést k poškození funkčních částí armatury. Na takto vzniknuté škody se záruka firmy Hansgrohe nevztahuje.
- Tento produkt nemůže být používán ve spojení s hydraulicky a teplotně řízenými průtokovými ohřivači.

Technické údaje

Provozní tlak:	max. 0,6 MPa
Doporučený provozní tlak: (1 MPa = 10 bar = 147 PSI)	0,2 – 0,4 MPa
Teplota horké vody:	max. 60 °C
Doporučená teplota horké vody:	42 °C
Teplná desinfekce:	max. 70 °C / 4 min

Popis symbolů



Nepoužívat silikon s obsahem kyseliny octové!



Rozměry (viz strana 31)



Diagram průtoku (viz strana 32 - 45)



Příklady montáže (viz strana 32 - 45)



Střed sprchové vany



Teplá voda



Studená voda



V této oblasti je potřebné zesílení stěny.



Podomítkový uzavírací ventil



Quattro čtyřcestné přestavování

Quattro



Trio Universal - Uzavírací a přepínací ventil



Trio

Nepoužitý vývod musí být utěsněn zaslepovací zátkou.



> 50 l/min

Odtokový výkon musí být vyšší než 50 l/min.



Raindrain

Odtok



Čištění (viz strana 49)



Noste ochranné rukavice



Noste ochranné brýle



Odvápňovač (báze kyseliny citrónové)

Zabraňte styku s pokožkou a očima. Zasáhne-li výrobek oči, důkladně je vypláchněte vodou.



Přírodní mořská houba



Servisní díly (viz strana 52)





⚠ Bezpečnostné pokyny

- ⚠ Pri montáži musíte nosiť rukavice, aby ste predišli pomliaždeninám a rezným poraneniam.
- ⚠ Rameno držiaka hlavice sprchy je určené len na uchytienie hlavice sprchy a nesmie sa zaťažovať inými predmetmi!
- ⚠ Sprchovací systém nesmú bez dozoru používať deti, ako aj dospelé osoby s telesným, duševným a/alebo zmyslovým postihnutím. Sprchovací systém nesmú používať ani osoby, ktoré sú pod vplyvom alkoholu alebo drog.
- ⚠ Vyhybajte sa kontaktu vodného lúča sprchy s citlivými miestami tela (napr. oči). Dodržiavajte dostatočnú vzdialenosť medzi sprchou a telom.
- ⚠ Sprchovací systém sa smie používať len na kúpanie a telesnú hygienu.
- ⚠ Veľké rozdiely v tlaku medzi prípojkami studenej a teplej vody musia byť vyrovnané.

Pokyny pre montáž

- Ledningarna och blandaren måste monteras, spolas igenom och kontrolleras enligt de gällande normerna.
- Pred montážou musíte produkt skontrolovať, či nebol počas transportu poškodený. Po zabudovaní nebudú uznané žiadne škody spôsobené transportom alebo poškodenia povrchu.
- Pri montáži produktu kvalifikovanou osobou treba dávať pozor na to, aby bola upevňovacia plocha v celej oblasti upevnenia rovná (žiadne vyčnievajúce medzery alebo zapustenia obkladov), aby štruktúra steny bola vhodná pre montáž produktu a nemá žiadne slabé miesta.
- Sítka na zachytávanie nečistôt musíte zabudovať, aby ste zabránili nečistotám vyplaveným z vodovodnej siete. Vyplavené nečistoty môžu ovplyvniť funkciu sprchy a/alebo môžu viesť k poškodeniu funkčných častí armatúry. Na takto vzniknuté škody sa záruka firmy Hansgrohe nevzťahuje.
- Tento produkt sa nesmie používať v spojení s hydraulicky a teplotne riadenými prietokovými ohrievačmi.

Technické údaje

Prevádzkový tlak:	max. 0,6 MPa
Doporučený prevádzkový tlak: (1 MPa = 10 bar = 147 PSI)	0,2 - 0,4 MPa
Teplota teplej vody:	max. 60°C
Doporučená teplota teplej vody:	42°C
Termická dezinfekcia:	max. 70°C / 4 min

Popis symbolov



Nepoužívať silikón s obsahom kyseliny octovej!



Rozmery (viď strana 31)



Diagram prietoku (viď strana 32 - 45)



Príklady montáže (viď strana 32 - 45)



Stred sprchovej vane



Teplá voda



Studená voda



V tejto oblasti je potrebné zosilnenie steny.



Podomietkový uzatvárací ventil



Quattro štvorcestné prestavenie

Quattro



Trio univerzálny uzatvárací a prestavovací ventil



Trio



Nepoužitý vývod musí byť zaslepený zátkou.



> 50 l/min

Výkon odtoku musí byť vyšší ako 50 l/min.



Raindrain

Odtok



Čistení (viď strana 49)



Noste ochranné rukavice



Noste ochranné okuliare



Odvápňovač (báza kyseliny citrónovej)

Zabráňte styku s pokožkou a očami. Ak produkt zasiahne oči, dôkladne ich vypláchnite vodou.



Prírodná morská huba



Servisné diely (viď strana 52)





△ 安全技巧

- △ 装配时为避免挤压和切割受伤，必须戴上手套。
- △ 头顶莲蓬头夹持杆只为夹持头顶莲蓬头而设计，不得让其承载其它物品！
- △ 不得让儿童和肢体、精神和/或意识有障碍的成人在不受监管的情况下使用淋浴系统。受酒精或毒品影响的人员不得使用淋浴系统。
- △ 必须避免让身体敏感部位（如眼睛）接触到莲蓬头喷水。必须保持莲蓬头与人头之间有足够的距离。
- △ 淋浴系统只允许作为洗浴、卫生和洁身之用。
- △ 冷热水管间过大的压力差必须予以平衡。

安装提示

- 管道和阀门必须根据通用标准进行安装、冲洗和检查。
- 安装前必须检查产品是否受到运输损害。安装后将不认可运输损害或表面损伤。
- 由有资格的专业人员进行产品安装时请注意：在所有加固区域中，加固表面是否平整（无突出的接缝或瓷砖），墙体结构是否适合产品安装且未显露出任何缺点。
- 必须安装接污滤网，以免从管网中冲入污物。一旦污物冲入，将会有碍功能和/或导致阀门功能部件的损坏，由此而产生的各种损害汉斯格雅公司将不承担责任。
- 该产品不可与液控和热控即热式热水器连接使用。

技术参数

工作压强:	最大 0,6 MPa
推荐工作压强:	0,2 0,4 MPa
(1 MPa = 10 bar = 147 PSI)	
热水温度:	最大 60° C
推荐热水温度:	42° C
热力消毒:	最大 70° C / 4 分钟

符号说明



请勿使用含有乙酸的硅！



大小 (参见第 31 页)



流量示意图 (参见第 32 - 45 页)



安装示意 (参见第页 32 - 45)



中心淋浴盆



热水



冷水



该区域需要一个加固边壁。



截止阀



Quattro 四通转换器



通用的三通截止阀和换向阀



插入不使用的插座。



排水功率必须大于 50 l/min.



排水口



清洗 (参见第 49 页)



配戴保护手套



配戴护眼用具



柔软剂 (柠檬酸)
避免眼睛和皮肤接触。如该产品不慎进入眼睛，立即用清水彻底冲洗。



天然海绵



备用零件 (参见第 52 页)



安装 参见第 46 页



⚠ Указания по технике безопасности

- ⚠ Во время монтажа следует надеть перчатки во избежание прищемления и порезов.
- ⚠ Кронштейн верхнего душа предназначен только для подсоединения верхнего душа. Запрещается подвешивать на него другие предметы!
- ⚠ Дети, а также взрослые с физическими, умственными и/или сенсорными недостатками должны пользоваться душевой системой только под присмотром. Запрещается пользоваться душевой системой в состоянии алкогольного или наркотического опьянения.
- ⚠ Не допускайте попадания струи воды из разбрызгивателя на чувствительные части тела (например, на глаза). Разбрызгиватель следует устанавливать на достаточном расстоянии от тела.
- ⚠ Душевую систему разрешается использовать только в гигиенических целях для принятия ванны и личной гигиены.
- ⚠ донного клапа. Перед установкой смесителя необходимо регулировочными кранами выровнять авление холодной и горячей воды при помощи вентилей регулирующих подачу воды в квартиру.

Указания по монтажу

- Трубы и арматура должны быть установлены, промыты и проверены в соответствии с действующими нормами.
- Перед монтажом следует проверить изделие на предмет повреждений при перевозке. После монтажа претензии о возмещении ущерба за повреждения при перевозке или повреждения поверхностей не принимаются.
- Во время монтажа изделия квалифицированным персоналом поверхность крепления должна быть ровной по всей области крепления (не допускайте выступающих стыков или перекоса облицовочной плитки); для монтажа изделия следует использовать подходящую стену достаточной прочности.
- Для предотвращения попадания загрязнений из водопроводной сети необходимо устанавливать грязеуловители. Частицы грязи могут нарушить работу и/или привести к повреждению функциональных деталей арматуры. Компания Hansgrohe не несет ответственности за подобные повреждения.
- Применение этой продукции при наличии гидравлических и проточных нагревателей с тепловой регулировкой не допускается.

Технические данные

Рабочее давление:	не более. 0,6 МПа
Рекомендуемое рабочее давление: (1 МПа = 10 bar = 147 PSI)	0,2 – 0,4 МПа
Температура горячей воды:	не более. 60°С
Рекомендуемая темп. гор. воды:	42°С
Термическая дезинфекция:	не более. 70°С / 4 мин

Описание символов



Не применяйте силикон, содержащий уксусную кислоту.



Размеры (см. стр. 31)



Схема потока (см. стр. 32 - 45)



варианты установки (см. стр. 32 - 45)



Середина душевой ванны



Теплая вода



Холодная вода



В этой области требуется укрепление стены.



Скрытый вентиль



Четырехходовой переключатель Quattro

Quattro



Трехходовой запорный и переключающий вентиль Trio Universal

Trio



Ненужный выход необходимо уплотнить с помощью заглушки.



Слив должен иметь производительность более 50 л/мин.

> 50 l/min



Слив

Raindrain



Очистка (см. стр. 49)



Носите защитные перчатки



Носите средства защиты глаз



Удалитель накипи (на основе лимонной кислоты)

Избегайте контакта с глазами и кожей. При попадании продукта в глаза, тщательно промойте их водой.
Губка из натурального волокна



Комплект (см. стр. 52)





⚠ Biztonsági utasítások

- ⚠ A szerelésnél a zúzódások és vágási sérülések elkerülése érdekében kesztyűt kell viselni.
- ⚠ A zuhanyfej karja csak a zuhanyfej tartására alkalmas, és nem szabad más tárgyakkal megterhelni!
- ⚠ Gyermekek, valamint testileg, szellemileg fogyatékos vagy érzékelésben korlátozott személyek nem használhatják felügyelet nélkül a zuhanyrendszert. Alkohol és kábítószer befolyása alatt álló személyek nem használhatják a zuhanyrendszert.
- ⚠ Kerülni kell a zuhany sugár érintkezését érzékeny testrészekkel (pl. szemek). Be kell tartani a megfelelő távolságot a zuhanyfej és a test között.
- ⚠ A zuhanyrendszert csak fürdéshez, mosakodáshoz és egészségügyi tisztálkodáshoz szabad használni.
- ⚠ A hidegvíz- és a melegvíz-csatlakozások közötti nagy nyomáskülönbséget kikell egyenlíteni!

Szerelési utasítások

- A vezetékeket és a csaptelepet az érvényes szabványoknak megfelelően kell felszerelni, öblíteni és ellenőrizni
- A szerelés előtt ellenőrizni kell, hogy a terméknek nincs-e szállítási sérülése. Beépítés után a szállítási- vagy felületi sérüléseket nem ismerik el.
- A termék képzett szakember általi felszerelése esetén ügyelni kell arra, hogy a rögzítési felület teljesen sima legyen (ne legyen kiálló fuga vagy csempe), a fal szerkezete a termék felszerelésére alkalmas legyen, és ne legyen gyenge pontja.
- A szűrőtömitéseket be kell szerelni a vízhálózatból származó szennyeződések kiküszöbölésére. A beáramló szennyeződések akadályozhatják és /vagy teljesen tönkre is tehetik a csaptelep funkcióit. Az ezekből adódó károkért a Hansgrohe nem felel.
- Ha a zuhany működik, akkor ennek a zuhanykarral együtt kb. 10 kg a tömege. Ezért csak a falnak megfelelő rögzítő anyagot szabad használni! A mellékelt csavarok és tiplik csak tömör falakhoz használhatók.

Műszaki adatok

Üzemi nyomás:	max. 0,6 MPa
Ajánlott üzemi nyomás: (1 MPa = 10 bar = 147 PSI)	0,2 - 0,4 MPa
Forróvíz hőmérséklet:	max. 60°C
Forróvíz javasolt hőmérséklete:	42°C
Termikus fertőtlenítés:	max. 70°C / 4 perc

Szimbólumok leírása



Ne használjon ecetsavtartalmú szilikonot!



Méretet (lásd a 31. oldalon)



Átfolyási diagramm (lásd a 32 - 45. oldalon)



Szerelési példák (lásd a oldalon 32 - 45)



Zuhanytálca közepe



Melegvíz



Hidegvíz



Ezen a területen a fal megerősítésére van szükség.



Falsík alatti szelep



Quattro négy-utas átalakító

Quattro



Trio univerzális záró- és váltószelep

Trio



A fölösleges kimenetet vakdugóval kell lezárni.



A lefolyó teljesítményének 50l/percnél magasabbnak kell lenni

> 50 l/min



Lefolyó

Raindrain



Tisztítás (lásd a 49. oldalon)



Viseljen védkesztyűt



Viseljen szemvédőt



Vízkeőoldó (citromsav alapú)

Kerülje a szemmel és bőrrel való érintkezést. Ha a termék a szembe jut, akkor bő vízzel mossa ki.



Természetes szivacs



Tartozékok (lásd a 52. oldalon)



Szerelés lásd a 46. oldalon



△ Turvallisuusohjeet

- △ Asennuksessa on käytettävä käsiineitä puristumien ja viiltojen aiheuttamien tapaturmien estämiseksi.
- △ Pääsuihkun varsi on tarkoitettu vain kannattamaan pääsuihkua. Sitä ei saa kuormittaa muilla esineillä!
- △ Lapset ja ruumiillisesti, henkisesti ja/tai aistillisesti rajoittuneet aikuiset eivät saa käyttää suihkujärjestelmää ilman valvontaa. Alkoholin tai huumeiden vaikutuksessa olevat henkilöt eivät saa käyttää suihkujärjestelmää.
- △ Suihkuveden kontaktia herkkien ruumiinosien (esim. silmien) kanssa on vältettävä. Suihkun ja vartalon välissä on oltava riittävä väli.
- △ Suihkujärjestelmää saa käyttää ainoastaan kylpy-, hygienia- ja puhdistustarkoituksiin.
- △ Suuret paine-erot kylmä- ja kuumavesiliitäntöjen välillä on tasattava.

Asennusohjeet

- Putket ja hana on asennettava, huuhdeltava ja tarkastettava voimassa olevien standardien mukaisesti.
- Ennen asennusta on tarkastettava tuotteen mahdolliset kuljetusvahingot. Asennuksen jälkeen kuljetus- ja pintavaurioita ei hyväksytä.
- Pätevän ammattihenkilöstön asentaessa tuotetta on otettava huomioon, että kiinnityspinnan on oltava koko kiinnitysalueelta tasainen (ei korkeita saumoja tai laattojen yhtymäkohtia), seinän rakenne soveltuu tuotteen asennukseen eikä siinä ole heikkoja kohtia.
- Likasihdit on asennettava, jotta lian huuhtoutuminen vesijohtoverkosta voidaan välttää. Huuhtoutuvat likahiukkaset voivat häiritä hanan toimintaa ja/tai vahingoittaa sen toimintaosia, Hansgrohe ei vastaa tästä aiheutuneista vahingoista.
- Tätä tuotetta ei voi käyttää hydraulisesti tai termisesti ohjattujen läpivirtauskuumentimien yhteydessä.

Tekniset tiedot

Käyttöpaine:	maks. 0,6 MPa
Suosittelu käyttöpaine: (1 MPa = 10 bar = 147 PSI)	0,2 – 0,4 MPa
Kuuman veden lämpötila:	maks. 60°C
Kuuman veden suosituslämpötila:	42°C
Lämpödesinfektio:	maks. 70°C / 4 min

Merkin kuvaus



Älä käytä etikkahappopitoista silikonial!



Mitat (katso sivu 31)



Virtausdiagrammi (katso sivu 32 - 45)



Asennusesimerkkejä (katso sivu 32 - 45)



Suihkultaan keskusta



Lämmin vesi



Kylmä vesi



Tässä kohdassa seinää on vahvistettava



Upotettava venttiili



4-tiesäätöventtiili

Quattro



Trio -sulku- ja säätöventtiili



Trio

Käyttämätön lähtöliitin on suljettava sulkutulpalla.



> 50 l/min

Poisvirtaustehon on oltava enemmän kuin 50l/min.



Raindrain

Veden poisvirtaus



Puhdistus (katso sivu 49)



Käytä suojakäsineitä



Käytä silmäsuojuksia



Kalkinpoistaja
(sitruunahappopohjainen)

Vältä silmä- ja ihokosketusta. Jos tuotetta pääsee silmiin, huuhtele silmät perusteellisesti vedellä.



Luonnonsieni



Varaosat (katso sivu 52)





⚠ Säkerhetsanvisningar

- ⚠ Handskar ska bäras under monteringsarbetet så att man kan undvika kläm- och skärskadorgen werden.
- ⚠ Armen som håller huvudduschen är bara konstruerad för detta; den får inte belastas med andra föremål!
- ⚠ Barn samt vuxna med fysiska, psykiska eller sensoriska funktionshinder får inte använda duschsystemet ensamma. Personer som är påverkade av alkohol- eller droger får inte använda duschsystemet.
- ⚠ Undvik att rikta duschstrålarna mot känsliga kroppsdelar (t. ex. ögonen). Det måste finnas ett tillräckligt stort avstånd mellan duschen och kroppen.
- ⚠ Duschsystemet får bara användas till kroppshygien med bad och dusch.
- ⚠ Stora tryckskillnader mellan anslutningarna för varmt och kallt vatten måste utjämnas.

Monteringsanvisningar

- Ledningarna och blandaren måste monteras, spolats igenom och kontrolleras enligt de gällande normerna.
- Det måste undersökas om produkten har transportskador innan den monteras. Efter monteringen accepteras inga transport- eller ytskiktsskador.
- Atlikdami montavimo darbus, kvalifikuoti darbuotojai turi atkreipti dėmesį, kad pritvirtinimo plokštuma būtų lygi (be išsikišusių siūlių ar perkreiptų plytelių), sienų konstrukcija tiktų gaminiui montuoti ir neturėtų jokių trūkumų.
- Smutsfiltren måste monteras så att inte smuts från ledningsnätet kan tränga in. Smuts som spolats in kan påverka funktionen och/eller leda till skador på funktionsdelar i armatyren. Hansgrohe fransäger sig allt ansvar för skador som kan härledas till detta.
- Denna produkt kan inte användas tillsammans med hydrauliskt och termiskt styrda varmvattenberedare.

Tekniska data

Driftstryck:	max. 0,6 MPa
Rek. driftstryck:	0,2 – 0,4 MPa
(1 MPa = 10 bar = 147 PSI)	
Varmvattentemperatur:	max. 60 °C
Rek. varmvattentemp.:	42 °C
Termisk desinfektion:	max. 70 °C / 4 min

Simbolio aprašymas



Använd inte silikon som innehåller ättiksyra!



Måtten (se sidan 31)



Pralaidumo diagrama (se sidan 32 - 45)



Monteringsexempel (se sidan 32 - 45)



Mitten av duschkaret



Varmvatten



Kallvatten



Šioje zonoje būtinas sienos sutvirtinimas



Invändig ventil



Quattro Fyrvägsomkastare

Quattro



Trio

Trio Universell avstängningsventil och omkastare



Det utlopp som inte behövs måste tätas med en blindstopp.



Avloppet måste klara mer än 50 l/min.

> 50 l/min



Raindrain

Avlopp



Rengöring (se sidan 49)



Bär skyddshandskar



Bär ögonskydd



Avkalkningsmedel (citrinos rūgšties pagrindu)

Undvik ögon- och hudkontakt. Skulle produkten hamna i ögonen så spola ur dem grundligt med vatten.
Natursvamp



Reservdelar (se sidan 52)



**⚠ Saugumo technikos nurodymai**

- ⚠ Apsaugai nuo užspaudimo ir įsijojimo montavimo metu mūvėkite pirštines.
- ⚠ Dušo laikiklis skirtas tik dušo galvutei laikyti, todėl neturi būti apkraunamas kitokiais daiktais!
- ⚠ Dušo sistema uždrausta naudotis vaikams, taip pat suaugusiems su fizine, dvasine negale ir (arba) sensorikos sutrikimais. Dušo sistema taip pat uždrausta naudotis asmenims, apsvaigusiems nuo alkoholio arba narkotikų.
- ⚠ Būtina vengti dušo vandens srovės kontakto su jautriomis kūno vietomis (pvz., akimis). Todėl būtina laikytis tinkamo atstumo nuo dušo.
- ⚠ Dušo sistema turi būti naudojama tik kūno higienai ir švarai palaikyti.
- ⚠ Turi būti išlyginti šalto ir karšto slėgio nelygumai.

Montavimo instrukcija

- Vamzdžiai ir sujungimai turi būti montuojami, plaunami ir tikrinami pagal galiojančias normas.
- Prieš montuojant būtina patikrinti, ar gaminys nebuvo pažeistas transportavimo metu. Sumontavus pretenzijos dėl transportavimo ir paviršiaus pažeidimų nepriimamos.
- Atlikdami montavimo darbus, kvalifikuoti darbuotojai turi atkreipti dėmesį, kad pritvirtinimo plokštuma būtų lygi (be išsikišusių siūlių ar perkreiptų plytelių), sienų konstrukcija tinkama gaminiui montuoti ir neturėtų jokių trūkumų.
- Turu būti įmontuoti tinkliniai filtrai; jie apsaugo nuo kietųjų dalelių, kurios gali patekti iš vandentiekio. Kietosios dalelės gali sutrikdyti santechnikos jungčių darbą ir (arba) pakenkti jų funkcinėms dalims. „Hansgrohe“ neatsako už gedimus dėl neįmontuoto filtro.
- Šio produkto negalima naudoti kartu su hidrauliškai ir termiškai valdomu tekančio vandens šildytuvu.

Techniniai duomenys

Darbinis slėgis:	ne daugiau kaip 0,6 MPa
Rekomenduojamas slėgis: (1 MPa = 10 barų = 147 PSI)	0,2 – 0,4 MPa
Karšto vandens temperatūra:	ne daugiau kaip 60°C
Rekomenduojama karšto vandens temperatūra:	42°C Terminis dezinfekavimas:
	ne daugiau kaip 70°C / 4 min

Simbolio aprašymas

Nenaudokite silikono, kurio sudėtyje yra acto rūgšties!

**Išmatavimai** (žr. psl. 31)**Pralaidumo diagrama** (žr. psl. 32 - 45)**Montavimo pavyzdžiai** (žr. psl. 32 - 45)

Dušo padėklo centras



Šiltas vanduo



Šaltas vanduo



Šioje zonoje būtinas sienos sutvirtinimas



Potinkinis uždarymo vožtuvas



„Quattro“ 4-krypčių perjungimas

Quattro

Užtvarinis ir perjungimo vožtuvas „Trio Universal“



Nenaudojamą išėjimą užaklinti.



Nutekėjimo našumas turi būti ne mažesnis 50 l/min

> 50 l/min

Nutekėjimas

**Raindrain****Valymas** (žr. psl. 49)

Mūvėkite apsaugines pirštines



Dėvėkite akių apsaugines priemones

**Nukalkintojas** (citrinos rūgšties pagrindu)

Venkite, kad produkto nepatektų į akis ir ant odos. Patekus į akis, jas kruopščiai nuplaukite vandeniu.



Natūrali kempinė

**Atsarginės dalys** (žr. psl. 52)



⚠ Sigurnosne upute

- ⚠ Prilikom montaže se radi sprječavanja prignječenja i posjekotina moraju nositi rukavice.
- ⚠ Nosač tuša iznad glave je dimenzioniran samo za držanje danog tuša i ne smije se opterećivati drugim predmetima!
- ⚠ Djeca, kao i tjelesno, mentalno i/ili senzorno hendikepirane odrasle osobe ne smiju se koristiti sustavom tuša bez nadzora. Osobe koje su pod utjecajem alkohola ili droga ne smiju se koristiti sustavom tuša.
- ⚠ Mora se izbjegavati kontakt mlaza iz tuša s osjetljivim dijelovima tijela (npr. očima). Tijelo korisnika mora biti dovoljno udaljeno od tuša.
- ⚠ Sustav tuša se smije primjenjivati samo za kupanje, tuširanje i osobnu higijenu.
- ⚠ Velika razlika u pritisku između vruće i hladne vode mora biti izbalansirana.

Upute za montažu

- Cijevi i armatura moraju biti postavljeni, isprani i testirani prema važećim normama.
- Prije montaže mora se provjeriti je li proizvod oštećen prilikom transporta. Nakon ugradnje se ne priznaju nikakve reklamacije koje se odnose na površinska i transportna oštećenja.
- Kada proizvod montira kvalificirano stručno osoblje treba paziti da čitava površina na koju se učvršćuje bude ravna (bez istaknutih fuga ili krivljenja pločica), da je zidna konstrukcija primjerena montaži proizvoda te da nema slabih mjesta.
- Obvezno postavite mrežice za hvatanje prljavštine kako biste izbjegli prodiranje onečišćenja iz vodovoda. Prljavština može dovesti do djelomičnog ili potpunog oštećenja dijelova armature. Za eventualna oštećenja uzrokovana prljavštinom proizvođač Hansgrohe ne preuzima nikakvu odgovornost.
- Ovaj proizvod se ne može rabiti uz hidraulički i termički regulirane protočne bojlere.

Tehnički podatci

Najveći dopušteni tlak:

Preporučeni tlak:

(1 MPa = 10 bar = 147 PSI)

Temperatura vruće vode:

Preporučena temperatura vruće vode:

Termička dezinfekcija:

tlak 0,6 MPa

0,2 – 0,4 MPa

tlak 60 °C

42 °C

tlak 70 °C / 4 min

Opis simbola



Nemojte koristiti silikon koji sadrži octenu kiselinu!



Mjere (pogledaj stranicu 31)



Dijagram protoka (pogledaj stranicu 32 - 45)



Primjeri instalacija (pogledaj stranicu 32 - 45)



Sredina tuš-kada



topla voda



hladna voda



U ovom je području potrebno ojačanje zida.



Podžbukni ventil



Quattro četverostruki preusmjerivač

Quattro



Trio Universal ventil za zatvaranje i ventil selektora

Trio



Potrebno je ostaviti zatvoren izlaz koji se ne koristi



> 50 l/min

Protok vode mora biti veći od 50 l/min.



Raindrain

Odvod



Čišćenje (pogledaj stranicu 49)



Nosite zaštitne rukavice



Nosite zaštitne naočale



Sredstvo za uklanjanje kamenca
(na bazi limunske kiseline)

Izbjegavajte kontakt s očima i kožom. U slučaju kontakta s očima, temeljito isperite s dosta vode.



prirodna spužva



Rezervni dijelovi (pogledaj stranicu 52)





⚠️ Güvenlik uyarıları

- ⚠️ Montaj esnasında ezilme ve kesilme gibi yaralanmaları önlemek için eldiven kullanılmalıdır.
- ⚠️ Başlıklı püskürtücü kolu yalnızca başlıklı püskürtücünün tutulması için tasarlanmıştır, başka nesnelere üzerine yük bindirilmemelidir!
- ⚠️ Bedensel, ruhsal ve/veya sensörük engelli çocuk ve yetişkinler gözetimsiz olarak duş sistemini kullanmamalıdır. Alkol veya uyuşturucu etkisinde olanlar duş sistemini kullanmamalıdır.
- ⚠️ Püskürtme başlıklarının hassas organlara teması (örn. gözler) önlenmelidir. Püskürtücü ile beden arasında yeterli mesafe bırakılmalıdır.
- ⚠️ Duş sistemi yalnızca banyo, hijyen ve beden temizliği amaçları doğrultusunda kullanılabilir.
- ⚠️ Sıcak ve soğuk su bağlantıları arasında büyük basınç farklılıkları varsa, bu basınç farklılıklarının dengelenmesi gerekir.

Montaj açıklamaları

- Boruların ve armatürün montajı, yıkanması ve kontrolü geçerli normlara göre yapılmalıdır.
- Montaj işleminden önce ürün nakliye hasarları yönünden kontrol edilmelidir. Montaj işleminden sonra nakliye veya yüzey hasarları için sorumluluk üstlenilmemektedir.
- Ürünün yetkili uzman personel tarafından montajı yapılırken, sabitleme yüzeyinin sabitleme planının tüm alanında bulunduğu (derz veya fayans kayması olmamalıdır), duvar yapısının ürünün montajı için uygun olduğuna ve zayıf noktaları bulunmadığına dikkat edilmelidir.
- Şebeke borusunda kir oluşumunu önlemek için kir toplama eleklerinin takılması gereklidir. Kirlenmeler işlevi olumsuz etkileyebilir ve/veya armatürün işlev parçalarında hasarlara yol açabilir. Hansgrohe, bundan dolayı kaynaklanabilecek hasarlara karşı sorumluluk üstlenmez.
- Bu ürün hidrolik ve termik kumandalı akış ısıtıcılarıyla bağlantılı olarak kullanılmamalıdır.

Teknik bilgiler

İşletme basıncı:	azami 0,6 MPa
Tavsiye edilen işletme basıncı: (1 MPa = 10 bar = 147 PSI)	0,2 - 0,4 MPa
Sıcak su sıcaklığı:	azami 60 °C
Tavsiye edilen su ısısı:	42 °C
Termik dezenfeksiyon:	azami 70 °C / 4 dak

Simge açıklaması



Asetik asit içeren silikon kullanmayın!



Ölçüleri (Bakınız sayfa 31)



Akış diyagramı (Bakınız sayfa 32 - 45)



Montaj Örneği (bakınız sayfa 32 - 45)



Duş küvetinin ortası



Sıcak su



Soğuk su



Bu alanda duvarın kalınlaştırılması gereklidir.



Sıva altı valfı



Quattro dört yönlü değiştirme



Quattro

Trio üniversal kapatma ve değiştirme valfı



Trio



Kullanılmayan çıkış bir kör tapayla izole edilmelidir.



Akış kapasitesi 50 l/dak üzerinde olmalıdır.

> 50 l/min

Akış



Raindrain



Temizleme (Bakınız sayfa 49)



Koruyucu eldiven kullanın



Göz koruyucu kullanın



Kireç sökücü (Limon asidi temeli)

Gözlere ve cilde temasından kaçınınız. Eğer ürün gözlere bulaşırsa, gözlerinizi su ile iyice yıkayınız.



Doğal Sünger



Yedek Parçalar (Bakınız sayfa 52)





⚠️ Instrucțiuni de siguranță

- ⚠️ La montare utilizați mănuși pentru evitarea contuziunilor și tăierii mâinilor.
- ⚠️ Brațul parei de duș este destinat doar pentru a susține para, acesta nu poate fi prevăzut cu alte obiecte.
- ⚠️ Copiii și adulții cu dizabilități corporale, mintale și senzoriale nu pot utiliza sistemul de duș nesupravegheați. De asemenea este interzisă utilizarea sistemului de duș de către persoane, care se află sub influența alcoolului sau a drogurilor.
- ⚠️ Evitați contactul jetului de apă cu părțile de corp sensibile (de ex. ochii). Țineți dușul la o distanță corespunzătoare de corp.
- ⚠️ Sistemul de duș poate fi utilizat doar pentru spălarea, menținerea igienei și curățarea corpului.
- ⚠️ Diferențele de presiune mari între alimentarea cu apă rece și apă caldă trebuie echilibrate.

Instrucțiuni de montare

- Conductele și bateriile trebuie montate, spălate și verificate conform normelor în vigoare.
- Înainte de instalare verificați, dacă produsul prezintă deteriorări de transport. După instalare garanția nu acoperă deteriorările de transport și cele de suprafață.
- La montarea produsului de către un personal calificat se va avea grijă ca suprafața de fixare să fie plană pe toată aria de fixare (fără proeminențe ale rosturilor sau îmbinări între plăcile de faianță) și ca structura peretelui să fie corespunzătoare pentru fixarea produsului, să nu prezinte locuri cu rezistență redusă.
- Sitele pentru reținerea impurităților trebuie montate pentru evitarea pătrunderii impurităților din rețeaua de alimentare. Impuritățile pătrunse pot influența funcționarea și/sau pot provoca deteriorarea părților funcționale ale armăturilor. Garanția Hansgrohe nu acoperă aceste daune.
- Acest produs nu poate fi utilizat în combinație cu boilere cu flux continuu hidraulice sau comandate termic.

Date tehnice

Presiune de funcționare:	max. 0,6 MPa
Presiune de funcționare recomandată: (1 MPa = 10 bar = 147 PSI)	0,2 - 0,4 MPa
Temperatura apei calde:	max. 60 °C
Temperatura recomandată a apei calde:	42 °C
Dezinfecție termică:	max. 70 °C / 4 min

Descrierea simbolurilor



Nu utilizați silicon cu conținut de acid acetic!



Dimensiuni (vezi pag. 31)



Diagrama de debit (vezi pag. 32 - 45)



Exemple de montare (vezi pag. 32 - 45)

X

În mijlocul căzii de duș



Apă caldă



Apă rece



În această zonă este nevoie de întărirea peretelui.



Ventil montat sub tencuială



Quattro valvă de inversare cu patru căi

Quattro



Trio valvă de închidere și de inversare universală

Trio



Racordurile neutilizate trebuie acoperite cu dop etanș.



Capacitatea de evacuare trebuie să fie mai mare de 50 l/min.

> 50 l/min



Deversor

Raindrain



Curățare (vezi pag. 49)



Purtați mănuși de protecție



Purtați ochelari de protecție



Soluție de decalcifiere (bază de acid citric)

Evitați contactul cu ochii și cu pielea. În cazul în care produsul ajunge în contact cu ochii, clătiți bine cu apă.
Burete natural



Piese de schimb (vezi pag. 52)





⚠ Υποδείξεις ασφαλείας

- ⚠ Για να αποφύγετε τραυματισμούς κατά τη συναρμολόγηση πρέπει να φοράτε γάντια.
- ⚠ Ο βραχίονας του ντους κεφαλιού έχει μελετηθεί μόνο για να κρατά το ντους κεφαλιού, δεν επιτρέπεται να φορτίζεται με άλλα αντικείμενα!
- ⚠ Παιδιά ή ενήλικες με μειωμένες σωματικές, διανοητικές και/ή αισθητήριες ανεπάρκειες δεν επιτρέπεται να χρησιμοποιούν το σύστημα ντους χωρίς επίτηρηση. Άτομα υπό την επίρεια οινοπνεύματος ή ναρκωτικών δεν επιτρέπεται να χρησιμοποιούν σε καμία περίπτωση το
- ⚠ Η επαφή δέσμης νερού του ντους με ευαίσθητες περιοχές του σώματος (π.χ. μάτια) πρέπει να αποφεύγεται. Διατηρείτε επαρκή απόσταση ανάμεσα στο ντους και το σώμα.
- ⚠ Το σύστημα ντους επιτρέπεται να χρησιμοποιείται μόνο σαν μέσο λουτρού, υγιεινής και καθαρισμού του σώματος.
- ⚠ Οι διαφορές της πίεσης μεταξύ της σύνδεσης κρύου και ζεστού νερού θα πρέπει να αντισταθμίζονται.

Οδηγίες συναρμολόγησης

- Οι σωλήνες και η μπαταρία πρέπει να τοποθετηθούν σύμφωνα με τα ισχύοντα πρότυπα, να τεθούν υπό πίεση και να δοκιμαστούν.
- Πριν τη συναρμολόγηση πρέπει να εξεταστεί το προϊόν για ζημιές μεταφοράς. Μετά την εγκατάσταση δεν αναγνωρίζονται ζημιές από τη μεταφορά ή επιφανειακές ζημιές.
- Κατά τη συναρμολόγηση του προϊόντος από ειδικό προσωπικό θα πρέπει να ελέγχεται με ιδιαίτερη προσοχή η επιφάνεια στερέωσης, αν είναι επίπεδη σε όλη της την επιφάνεια (δεν πρέπει να εξέχουν αρμοί ή πλακάκια), αν η υποδομή του τοίχου είναι κατάλληλη για τη στερέωση του προϊόντος και αν παρουσιάζει ασθενή σημεία.
- Οι σήτες συλλογής ρύπων πρέπει να τοποθετηθούν, για να αποφεύγονται ρύποι που προέρχονται από το δίκτυο ύδρευσης. Οι ρύποι από το δίκτυο ύδρευσης μπορούν να επηρεάσουν αρνητικά και/ ή να προξενήσουν ζημιά στα λειτουργικά τμήματα της μπαταρίας. Τέτοιου είδους ζημιές δεν καλύπτονται από την εγγύηση της Hansgrohe
- Αυτό το προϊόν δεν μπορεί να χρησιμοποιηθεί σε συνδυασμό με υδραυλικούς και θερμικά ελεγχόμενους ταχυθερμοσίφωνες.

Τεχνικά Χαρακτηριστικά

Λειτουργία πίεσης:	έως 0,6 MPa
Συνιστώμενη λειτουργία πίεσης: (1 MPa = 10 bar = 147 PSI)	0,2 – 0,4 MPa
Θερμοκρασία ζεστού νερού:	έως 60°C
Συνιστώμενη θερμοκρασία ζεστού νερού:	42°C
Θερμική απολύμανση:	έως 70°C / 4 min

Περιγραφή συμβόλων



Μην χρησιμοποιείτε σιλικόνη που περιέχει οξικό οξύ!



Διαστάσεις (βλ. σελίδα 31)



Διάγραμμα ροής (βλ. σελίδα 32 - 45)



Παραδείγματα συναρμολόγησης (βλ. Σελίδα 32 - 45)



Μέσον της ντουσιέρας



Ζεστό νερό



Κρύο νερό



Σε αυτήν την περιοχή είναι απαραίτητη μία ενίσχυση του τοίχου.



Χωνευτή βαλβίδα



Quattro τετράοδος μετατροπής



Quattro

Trio Universal βαλβίδα κλεισίματος και εκτροπής



Trio

Τα περιττά στόμια εξόδου πρέπει να στεγανοποιηθούν με ένα τυφλό πώμα.



Η αποχετευτική ικανότητα της βαλβίδας εκροής πρέπει να υπερβαίνει τα 1/min.

> 50 l/min



Raindrain

Βαλβίδα εκροής



Καθαρισμός (βλ. σελίδα 49)



Φοράτε γάντια προστασίας χεριών



Φοράτε γυαλιά προστασίας ματιών



Αποσκληρυντής νερού (με βάση το κιτρικό οξύ)

Αποφεύγετε την επαφή με τα μάτια και το δέρμα. Σε περίπτωση που έλθει το προϊόν σε επαφή με τα μάτια ξεπλύνετε καλά με νερό. Φυσικός σπόγγος



Ανταλλακτικά (βλ. σελίδα 52)





⚠ Varnostna opozorila

- ⚠ Lors du montage, porter des gants de protection pour éviter toute blessure par écrasement ou coupure.
- ⚠ Nosilna roka naglavne prhe je konstruirana le za nošenje prhe in je ne smete obremeniti z drugimi predmeti!
- ⚠ Otroci kot tudi odrasle osebe z omejenimi telesnimi, duševnimi in/ali senzoričnimi sposobnostmi ne smejo nenadzorovano uporabljati sistema za prhanje. Osebe, ki so pod vplivom alkohola ali drog, sistema za prhanje ne smejo uporabljati.
- ⚠ Izogibati se je treba stiku prhalnega curka z občutljivimi deli telesa (npr. očmi). Med telesom in prho mora biti vedno zadosten razmik.
- ⚠ Sistem za prhanje se sme uporabljati le z namenom umivanja, vzdrževanja higiene in telesne nege.
- ⚠ Velike razlike v tlaku med priključkom za mrzlo in priključkom za toplo vodo je potrebno izravnati.

Navodila za montažo

- Cevi in armaturo je treba montirati, izprati in preveriti po veljavnih standardih.
- Pred montažo je treba izdelek preveriti glede morebitnih transportnih poškodb. Po vgradnji transportne ali površinske poškodbe ne bodo več priznane.
- Pri montaži tega proizvoda s strani kvalificiranega strokovnega osebja je treba paziti na to, da je pritrdilna ploskev na celotni površini za pritrditev gladka (brez izstopajočih fug ali zasekov ploščic), da je struktura stene primerna za montažo proizvoda in ne kaže šibkih mest.
- Vgradite je treba lovilnike umazanije, da se prepreči naplakovanje umazanije iz vodovodne napeljave. Naplake umazanije lahko ogrozijo delovanje in/ali povzročijo okvare na funkcionalnih delih armature. Za tako nastalo škodo podjetje Hansgrohe ne odgovarja.
- Tega proizvoda ni možno uporabiti v povezavi s hidravlično in termično krmiljenimi pretočnimi grelniki.

Tehnični podatki

Delovni tlak:	maks. 0,6 MPa
Priporočeni delovni tlak: (1 MPa = 10 bar = 147 PSI)	0,2 – 0,4 MPa
Temperatura tople vode:	maks. 60 °C
Priporočena temperatura tople vode:	42 °C
Termična dezinfekcija:	maks. 70 °C / 4 min

Opis simbola



Ne smete uporabiti silikona, ki vsebuje očetno kislino!



Mere (glejte stran 31)



Diagram pretoka (glejte stran 32 - 45)



Primeri montaže (glejte stran 32 - 45)



Sredina pršne kadi



Topla voda



Mrzla voda



V tem območju je potrebno ojačanje stene.



Podometni ventil



Quattro ütiripotna prestavitev

Quattro



Trio Universal zaporni in preklopni ventil



Izhod, ki ga ne potrebujete, zatesnite s čepom.



Odtokna kapacitetamora znašati več kot 50 l/min.

> 50 l/min

Odtok



Raindrain



Čiščenje (glejte stran 49)



Nosite zaščitne rokavice



Nosite zaščito za oči



Odstranjevalec apnenca (na osnovi citronske kisline)

Izogibajte se stiku z očmi in kožo. Če proizvod pride v oči, jih temeljito sperite z vodo.



Naravna gobica



Rezervni deli (glejte stran 52)





Ohutusjuhised

- △ Kandke paigaldamisel muljumis- ja löikevigastuste vältimiseks kindaid.
- △ Dušipea hoidik on mõeldud ainult dušipea hoidmiseks ja seda ei tohi muude esemetega koormata!
- △ Lapsed, samuti kehaliste, vaimsete või tajupiirangutega täiskasvanud ei tohi dušisüsteemi järelvalveta kasutada. Alkoholi või narkootikumide mõju all olevad isikud ei tohi dušisüsteemi kasutada.
- △ Duši veejoad ei tohi kokku puutuda tundlike kehaosadega (nt silmad). Jätke duši ja keha vahele piisav vahe.
- △ Dušisüsteemi tohib kasutada ainult pesemis-, hügieeni- ja kehapuhastamiseesmärkidel.
- △ Kui külma ja kuuma vee ühenduste surve on väga erinev, tuleb need tasakaalustada.

Paigaldamisjuhised

- Voolikute ja segisti paigaldamisel, loputamisel ja kontrollimisel tuleb lähtuda kehtivatest normatiividest
- Enne paigaldamist tuleb toodet kontrollida transpordikahjustuste osas. Pärast paigaldamist ei tunnustata enam transpordi- või pinnakahjustuste kaebuseid.
- Tootte paigaldamisel kvalifitseeritud spetsialistide poolt tuleb jälgida, et kinnituspind oleks kogu ulatuses ühtlaselt tasane (mitte ühtki üleseisvat vuuki või kaldus kahhelkivi), seina ülesehitus toote paigaldamiseks sobiv ja ilma nõrkade kohtadeta.
- Mustusesõelad tuleb paigaldada selleks, et eemaldada veevõrgust tulevaid mustuseosakesi. Mustuseosakesed võivad tööd segada ja/või armatuuri kahjustada, sellest tulenevate kahjude eest Hansgrohe ei vastuta.
- Seda toodet ei saa kasutada koos hüdrauliliselt ja termiliselt juhitava läbivoolusoojendiga.

Tehnilised andmed

Töörõhk	maks. 0,6 MPa
Soovitav töörõhk: (1 MPa = 10 baari = 147 PSI)	0,2 - 0,4 MPa
Kuuma vee temperatuur:	maks. 60°C
Soovitav kuuma vee temperatuur:	42°C
Termiline desinfektsioon:	maks. 70°C / 4 min

Sümbolite kirjeldus



Ärge kasutage äädikhapet sisaldavat silikooni!



Mõõtude (vt lk 31)



Läbivooludiagramm (vt lk 32 - 45)



Paigalduse näited (vt lk 32 - 45)



Dušivanni kese



Soe vesi



Külm vesi



Selles alas tuleb seina tugevdada.



peiteklapp



Quattro-liitmik

Quattro



Katkestus- ja ümberlülitusklapp Trio Universal



Äravoolu jõudlus peab olema suurem kui 50 l/min.

> 50 l/min

Äravoold



Raindrain



Puhastamine (vt lk 49)



Kandke kaitsekindaid



Kandke kaitseprille



Katlakivi eemaldaja (põhineb sidrunhappel)

Vältige kokkupuudet silmade ja nahaga. Kui toode satub silma, siis loputage silmi hoolikalt veega..



Looduslik svamm



Varuosad (vt lk 52)





⚠ Drošības norādes

- ⚠ Montāžas laikā, lai izvairītos no saspiedumiem un iegriezumiem, nepieciešams nēsāt cimdus.
- ⚠ Galvas dušas statīvs paredzēts vienīgi galvas dušas atbalstīšanai, to nedrīkst noslogot ar citiem priekšmetiem!
- ⚠ Bērni, kā arī pieaugušie ar fiziskiem, garīgiem un / vai sensoriskiem ierobežojumiem nedrīkst lietot šo dušas sistēmu bez uzraudzības. Personas, kas atrodas alkohola vai narkotisko vielu iespaidā, nedrīkst lietot šo dušas sistēmu.
- ⚠ Nepieciešams izvairīties no dušas strūkļas tieša kontakta ar jutīgām ķermeņa daļām (piem., acīm). Nepieciešams ievērot pietiekošu attālumu starp dušu un ķermeni.
- ⚠ Šo dušas sistēmu drīkst izmantot tikai, lai mazgātos, higiēnai un ķermeņa tīrīšanai.
- ⚠ Jāizlīdzina spiediena atšķirības starp aukstā un karstā ūdens pievadēm.

Norādījumi montāžai

- Cauruļvadi un armatūra ir jāuzstāda, jāizskalo un jāpārbauda saskaņā ar spēkā esošajiem standartiem.
- Pirms montāžas nepieciešams pārbaudīt, vai produktam transportēšanas laikā nav radušies bojājumi. Pēc iebūvēšanas bojājumi, kas radušies transportēšanas laikā, vai virsmas bojājumi netiek atzīti.
- Kvalificētiem speciālistiem, montējot produktu, jāpiegriež vērība tam, lai piestiprināšanas virsma visā piestiprināšanas zonā ir gluda (nav fūgu vai flīžu iecirtumu), sienas uzbūve ir piemērota produkta montāžai un tajā nav nestabilu vietu.
- Nepieciešams iemontēt neīrurumu aizturēšanas filtrus, lai novērstu neīrurumu ieplūšanu no ūdensvada. Ieskalotie neīrurumi var traucēt armatūras darbību un / vai arī izraisīt rokas dušas daļu bojājumus, par kuriem Hansgrohe nenes atbildību.
- Šo izstrādājumu nevar uzstādīt kopā ar hidrauliski un termiski vadītu caurplūdes sildītāju.

Tehniskie dati

Darba spiediens:	maks. 0,6 MPa
Ieteicamais darba spiediens: (1 MPa = 10 bar = 147 PSI)	0,2 - 0,4 MPa
Karstā ūdens temperatūra:	maks. 60°C
Ieteicamā karstā ūdens temperatūra:	42°C
Termiskā dezinfekcija :	maks. 70°C / 4 min

Simbolu nozīme



Neizmantot silikonu, kas satur etiķskābi!



Izmērus (skat. 31. lpp.)



Caurplūdes diagramma (skat. 32 - 45. lpp.)



Montāžas piemēri (skat. lpp. 32 - 45)



Dušas paliktņa vidus



Siltais ūdens



Aukstais ūdens



Šajā zonā ir nepieciešams pastiprināt sienu.



Zemapmetuma ventilis



Četrvirzienu pārslēgs

Quattro



Trīsvirzienu universālais noslēgvārsts un pārslēdzējvārsts

Trio



Neizmantoto izteku aizbāzīt ar aizbāzni.



Noteces veikspējai jābūt vairāk nekā 50 l/min.

> 50 l/min

Notece



Raindrain



Tīrīšana (skat. 49. lpp.)



Valkāt aizsargcimdus



Valkāt acu aizsargus



Atkalķotājs (uz citronskābes bāzes)

Novērst nokļūšanu acīs un uz ādas. Ja produkts iekļūst acīs, tās kārtīgi jāskalo ar ūdeni.



Dabīgais sūklis



Rezerves daļas (skat. 52. lpp.)





⚠ Sigurnosne napomene

- ⚠ Prilikom montaže se radi sprečavanja prignječenja i posekotina moraju nositi rukavice.
- ⚠ Nosač tuša iznad glave je dimenzioniran samo za držanje datog tuša i ne sme se opterećivati drugim predmetima!
- ⚠ Deca, kao i telesno, mentalno i/ili senzorno hendikepirane odrasle osobe ne smeju da koriste sistem tuša bez nadzora. Osobe koje su pod uticajem alkohola ili droga ne smeju da koriste sistem tuša.
- ⚠ Mora se izbegavati kontakt mlaza iz tuša sa osetljivim delovima tela (npr. očima). Telo korisnika mora biti na dovoljnom odstojanju od tuša.
- ⚠ Sistem tuša sme da se koristi samo za kupanje, tuširanje i ličnu higijenu.
- ⚠ Velika razlika u pritisku između vruće i hladne vode mora biti izbalansirana.

Instrukcije za montažu

- Vodovi i armatura moraju biti postavljeni, isprani i testirani prema važećim normama.
- Pre montaže se mora proveriti da li je proizvod oštećen pri transportu. Nakon ugradnje se ne priznaju nikakve reklamacije koje se odnose na površinska i transportna oštećenja.
- Kada proizvod montira kvalifikovano stručno osoblje treba paziti da čitava površina na koju se učvršćuje bude ravna (bez istaknutih fuga ili krivljenja pločica), da je zidna konstrukcija primerena montaži proizvoda i da nema slabih mesta.
- Obavezno ugradite mrežice za hvatanje prljavštine, čime sprečavate ulazak prljavštine iz vodovoda. Prljavština može dovesti do delimičnog ili potpunog oštećenja delova armature. Za eventualna oštećenja prouzrokovana prljavštinom proizvođač Hansgrohe nije odgovoran.
- Ovaj proizvod se ne može koristiti uz hidraulički i termički regulisane protočne bojlere.

Tehnički podaci

Radni pritisak:	maks. 0,6 MPa
Preporučeni radni pritisak: (1 MPa = 10 bar = 147 PSI)	0,2 - 0,4 MPa
Temperatura vruće vode:	maks. 60°C
Preporučena temperatura vruće vode:	42°C
Termička dezinfekcija:	maks. 70°C / 4 min

Opis simbola



Nemojte koristiti silikon koji sadrži sirćetnu kiselinu!



Mere (vidi stranu 31)



Dijagram protoka (vidi stranu 32 - 45)



Primeri montaže (vidi stranu 32 - 45)



Sredina tuš-kada



topla voda



hladna voda



U ovoj oblasti je potrebno ojačanje zida.



Uzidni ventil



Quattro četvorostruki preusmerivač

Quattro



Trio Universal ventil za zatvaranje i preklopni ventil



Izlaz koji se ne koristi, mora se zatvoriti slepim čepom.



> 50 l/min

Kapacitet odvoda mora biti veći od 50 l/min.



Ispust

Raindrain



Čišćenje (vidi stranu 49)



Nosite zaštitne rukavice



Nosite zaštitne naočare



Sredstvo za uklanjanje kamenca
(na bazi limunske kiseline)

Izbegavajte kontakt sa očima i kožom. U slučaju kontakta sa očima, dobro isperite sa dosta vode.



prirodni sunder



Rezervni delovi (vidi stranu 52)





⚠ Sikkerhets henvisninger

- ⚠ Bruk hansker under montasjen for å unngå klem- og kuttskader.
- ⚠ Armen til hodedusjen er kun laget for å holde hodedusjen. Den må ikke belastes med andre gjenstander!
- ⚠ Barn og voksne med fysiske og psykiske og/eller sensoriske handicap skal ikke bruke dusjsystemet uten oppsyn. Personer som er påvirket av alkohol eller narkotika skal ikke bruke dusjsystemet.
- ⚠ Dusjstrålen skal ikke komme i kontakt med ømfintlige kroppsdeler (f.eks. øynene). Overhold en tilstrekkelig avstand mellom dusjen og kroppen.
- ⚠ Dusjsystemet skal kun brukes for bade-, hygiene- og kropprensingsformål.
- ⚠ Store trykkdifferanser mellom kaldt- og varmtvannstilkoblinger skal utlignes.

Montage henvisninger

- Ledningene og armaturen skal monteres, spyles og sjekkes iht. de gjeldende normer.
- Før montasjen skal produktet sjekkes for transportskader. Etter monteringen aksepteres ikke noen transport- eller overflateskader.
- Under monteringen av produktet gjort av kvalifisert fagperson, skal man påse at monteringsoverflaten på hele festeområdet er plant (ingen utstikkende fuger eller flisekanter), at veggoppbyggingen egner seg for produktmontasjen og ikke viser svake punkter.
- Smussiler skal bygges inn for å forhindre at smuss spyles inn fra ledningsnett. Innspylt smuss kan påvirke funksjonen negativt og/eller kan medføre skader på funksjonsdeler til armaturer. Hansgrohe påtar seg inget ansvar for skader som resulteres av dette.
- Dette produktet kan ikke brukes i forbindelse med hydraulisk og termisk styrte gjennomstrømningovner.

Tekniske data

Driftstrykk	maks. 0,6 MPa
Anbefalt driftstrykk: (1 MPa = 10 bar = 147 PSI)	0,2 – 0,4 MPa
Varmtvannstemperatur	maks. 60 °C
Anbefalt temperatur for varmt vann	42 °C
Produktet er utelukkende designet for drikkevann!	maks. 70 °C / 4 min

Symbolbeskrivelse



Ikke bruk silikon som inneholder eddiksyre!



Mål (se side 31)



Gjennomstrømningsdiagram (se side 32 - 45)



Montasje-eksempel (se side 32 - 45)



Midten på dusjkar



Varmtvann



Kaldtvann



I dette området skal veggen forsterkes.



Innfelt ventil



Quattro fire-veis omstilling

Quattro



Trio universal stenge- og omstillingsventil



Trio

Utgangen som ikke brukes kan tettes med en blindplugg.



Avløp ytelse skal være mer enn 50 l/min.

> 50 l/min



Avløp

Raindrain



Rengjøring (se side 49)



Bruk vernehansker



Bruk vernebriller



Avkalker (sitronsyrebasert)

Unngå øye- og hudkontakt. Hvis produktet skulle komme i kontakt med øynene, skyll dem grundig med vann.



Natursvamp



Service deler (se side 52)





⚠ Указания за безопасност

- ⚠ При монтажа трябва да се носят ръкавици, за да се избегнат наранявания поради притискане или порязване.
- ⚠ Рамото на разпръсквателя за главата е разработена само, за да държи разпръсквателя за главата, то не бива да се натоварва с други предмети!
- ⚠ Не е позволено деца, както и възрастни с физически, умствени и / или сензорни ограничения да използват системата на душа без надзор. Не е позволено използването на системата на душа от лица, употребили алкохол или дрога.
- ⚠ Трябва да се избягва контакта на струите на разпръсквателя с чувствителни части на тялото (напр. очите). Между разпръсквателя и тялото трябва да се спазва достатъчно разстояние.
- ⚠ Позволено е използването на системата на душа само за къпане, хигиена и цели на почистване на тялото.
- ⚠ Големите разлики в налягането между изходите за студената и топлата вода трябва да се изравняват.

Указания за монтаж

- Тръбопроводите и арматурата трябва да се монтират, промият и проверят в съответствие с валидните норми.
- Преди монтажа продуктът трябва да се провери за транспортни щети. След монтажа не се признават транспортни или повърхностни щети.
- При монтаж на продукта от квалифицирани специалисти да се внимава за това, закрепващата повърхност в целия диапазон на закрепването да бъде равна (без изпъкнали fugи или изместване на плочки), конструкцията на стената да е подходяща за монтаж на продукта и да няма слаби места.
- Трябва да се монтират цедките за улавяне на замърсяванията, за да се избегне натрупването на замърсявания от водопроводната мрежа. Натрупването на замърсявания може да наруши функцията и/или да доведе до увреждания на функционалните части на арматурата, Hansgrohe не носи отговорност за получените се по този начин щети
- Този продукт не може да се използва във връзка с хидравлично и термично управляеми проточни нагреватели.

Технически данни

Работно налягане:	макс. 0,6 МПа
Препоръчително работно налягане: (1 МПа = 10 bar = 147 PSI)	0,2 - 0,4 МПа
Температура на горещата вода:	макс. 60 °C
Препоръчителна температура на горещата вода:	42 °C
Термична дезинфекция:	макс. 70 °C / 4 мин

Описание на символите



Не използвайте силикон, съдържащ оцетна киселина!



Размери (вижте стр. 31)



Диаграма на потока (вижте стр. 32 - 45)



Примери за монтаж (вижте стр. 32 - 45)



Среда на коритото на душ-кабината



Топла вода



Студена вода



В тази област е необходимо подсилване на стената.



Клапан за мазилка



Четирипътно превключване Quattro

Quattro



Спирателен и превключващ клапан Trio Universal

Trio



Излишният извод може да се уплътни с глуха пробка.



Мощността на изтичане трябва да бъде повече от 50 л/мин.

> 50 l/min



Отвеждане

Raindrain



Почистване (вижте стр. 49)



Носете защитни ръкавици



Носете защита за очите



Препарат за почистване на варовик (на базата на лимонова киселина)

Избягвайте контакт с очите и кожата. Ако продуктът попадне в очите Ви, изплакнете ги добре с вода. Естествен сунгер



Сервизни части (вижте стр. 52)





△ Udhëzime sigurie

- △ Për të evituar lëndimet e pickimeve ose të prerjeve gjatë procesit të montimit duhet që të vishni doreza.
- △ Mbatjesja e kokës së dushit është projektuar vetëm për mbajtjen e kokës së dushit dhe nuk duhet që të rëndohet me objekte të tjera!
- △ Fëmijët dhe të rriturit me aftësi të kufizuara fizike, mendore dhe/ose ndijuese nuk duhet ta përdorin sistemin e dushit pa qenë nën mbikëqyrje. Personat që janë nën ndikimin e drogave ose të alkoolit nuk duhet ta përdorin sistemin e dushit.
- △ Kontakti i valëve të dushit me pjesët e ndjeshme të trupit (p.sh. me sytë) duhet që të shmanget. Midis dushit dhe trupit duhet që të mbahet një distancë e mjaftueshme.
- △ Sistemi i dushit duhet të përdoret vetëm qëllimet e banjave, të higjienës dhe të larjes së trupit.
- △ Ndryshimet e mëdha të presionit mes lidhjeve të ujit të ftohtë dhe atij të ngrohtë duhen ekuilibruar.

Udhëzime për montimin

- Tubacionet dhe rubinetet duhet që të montohen, të shpëlahen dhe të kontrollohen sipas standardeve në fuqi
- Përpara montimit duhet që produkti të kontrollohet për dëmtime nga transporti. Pas instalimit nuk do të njihet asnjë dëmtim nga transporti ose dëmtim i sipërfaqes.
- Gjatë montimit të produktit nga teknikat e specializuara duhet mbajtur parasysh që sipërfaqja e montimit gjendet brenda zonës së përgjithshme të planit të montimit (nuk ka vendbashkime të dala ose mospërputhje të pllakave), që struktura e murit është e përshtatshme për montimin e produktit dhe që nuk paraqet asnjë pikë të dobët.
- Filtri i bllokimit të papastërtive duhet të instalohet për të parandaluar futjen e papastërtive nga rrjeti i tubacioneve të ujit. Futja e papastërtive mund të ndikojë në funksionimin dhe/ose mund të çojë në dëmtime të pjesëve funksionuese të rubinetit, dëmtime për të cilat Hansgrohe nuk mban asnjë përgjegjësi.
- Ky produkt nuk mund të përdoret me ngrohës elektrikë të ujit të drejtuara në mënyrë hidraulike ose termike.

Të dhëna teknike

Presioni gjatë punës	maks. 0,6 MPa
Presioni i rekomanduar: (1 MPa = 10 bar = 147 PSI)	0,2 - 0,4 MPa
Temperatura e ujit të ngrohtë	maks. 60°C
Temperatura e rekomanduar e ujit të ngrohtë:	42°C
Dezinfektim Termik:	maks. 70°C / 4 min

Përshkrimi i simbolit



Mos përdorni silikon që në përbërje ka acid acetik.



Përmasat (shih faqen 31)



Diagrami i qarkullimit (shih faqen 32 - 45)



Shembuj të montimit (shih faqen 32 - 45)



Mesi i vaskës së dushit



Uji i ngrohtë



Uji i ftohtë



Në këtë zonë është i nevojshëm një përforsim i murit.



Ventili i suvajës



Valvul devijuese Quattro me katër drejtime

Quattro



Valvul universale Trio për bllokim dhe devijim

Trio



Dalja që nuk nevojitet duhet izoluar me tapë qorre.



> 50 l/min

Kapaciteti i shkarkimit duhet të jetë më shumë se 50 l/minutë.



Raindrain

Shkarkimi



Pastrimi (shih faqen 49)



Vendosni doreza mbrojtëse



Vendosni mbrojtëse për sytë



Largues bigorri (me bazë acidi citrik)

Shmangni kontaktin me sytë dhe lëkurën. Nëse produkti bie në kontakt me sytë, shpëlaqini ato mirë me ujë të bollshëm.



Sfungjer natyral



Pjesë ndërrimi (shih faqen 52)





وصف الرمز

هام! لا تستخدم السليكون الذي يحتوي على أحماض!



أبعاد (راجع صفحة 31)



رسم للصرف (راجع صفحة 45 - 32)



مثال على التركيب (راجع صفحة 45 - 32)



باتيو مزود بدش في المنتصف



ماء دافئ



ماء بارد



يلزم هذا في النطاق وجود تقوية للحائط.



صمام التدفق



تغيير مسار رباعي كواترو



صمام حجز وتغيير تريبو يونيفرسال



قم بسد المنفذ غير المستخدم.



يجب أن تكون قدرة الصرف أكبر من 50 لتر/دقيقة



تصريف



التنظيف (راجع صفحة 49)



يجب ارتداء قفازات الحماية



يجب ارتداء تجهيزات حماية العين



مزيل نكلس (بحامض الليمون)

يجب تجنب ملامسة المنتج للعين والجلد. وفي حالة ملامسة المنتج للعين يجب غسلها جيداً بالماء.



إسفنجة طبيعية



قطع الغيار (راجع صفحة 52)



تنبيهات الأمان



- ⚠ يجب ارتداء قفازات لليد أثناء التركيب لتجنب حدوث أخطار الإنحشار أو الجروح.
- ⚠ وظيفة ذراع دش الرأس هي فقط الإمساك بدش الرأس، ولذلك يجب عدم التحميل عليه بأشياء أخرى.
- ⚠ ممنوع استخدام نظام الدش بدون ملاحظة من البالغين سواء في حالة استخدامه من طرف أطفال أو البالغين يعانون من قصور جسدي أو عقلي أو عصبي يمنعهم من الإحساس بدرجات حرارة المياه. لا يسمح لأي شخص تحت تأثير تناول الكحول أو المخدرات من استخدام نظام الدش.
- ⚠ يجب تجنب حدوث إتصال مباشر بين الماء الخارج من رأس الدش وبين أجزاء الجسم الحساسة (مثل العينين). يجب وجود مسافة كافية بين رأس الدش والجسم.
- ⚠ يجب استخدام نظام الدش فقط لأغراض الإستحمام والأغراض الصحية وأغراض تنظيف الجسم.
- ⚠ يجب أن يكون تيار الماء الساخن والماء البارد متعادلين في الضغط.

تعليمات التركيب

- يجب تركيب وغسيل واختبار التوصيلات وخلطات المياه طبقاً للمعايير السارية.
- قبل القيام بعملية التركيب، يجب فحص المنتج للتأكد من خلوه من أية تلفيات ناتجة عن النقل. بعد القيام بعملية التركيب، لن يتم الاعتراف بوجود أية تلفيات سطحية أو تلفيات ناتجة عن عملية النقل.
- عند التركيب بواسطة عمال تركيب متخصصين يجب الإنتباه إلى أن مساحة التثبيت في مكان التركيب بوجه عام مسطحة (لا توجد روابط أو فروق للربط بين البلاطات). لذا يجب التأكد من أن الحائط الذي سيتم تركيب المنتج عليه صالح لذلك وأنه لا يوجد به نقاط ضعف.
- يتعين تركيب شبكة تجميع الأوساخ من أجل تفادي خروج الأوساخ الواردة من شبكة المواسير. قد تتسبب الأوساخ الواردة في حدوث أعطال أو تلف أجزاء من الوحدة أو كليهما. وبالتالي، فإن هانز جروه لا تتحمل مسؤولية هذه الأعطال.
- لا يمكن استعمال هذا المنتج مع سخانات الماء الفورية الهيدروليكية أو الحرارية.

المواصفات الفنية

- ضغط التشغيل:
- ضغط التشغيل الموصى به:
- (1 ميجاباسكال = 10 بار = PSI 147)
- درجة حرارة الماء الساخن:
- درجة الحرارة الموصى بها للماء الساخن:
- تعقيم حراري:

الحد الأقصى 0,6 ميجاباسكال
0,4 - 0,2 ميجاباسكال

الحد الأقصى 60°C
42°C
الحد الأقصى 4 / 70°C الدقيقة



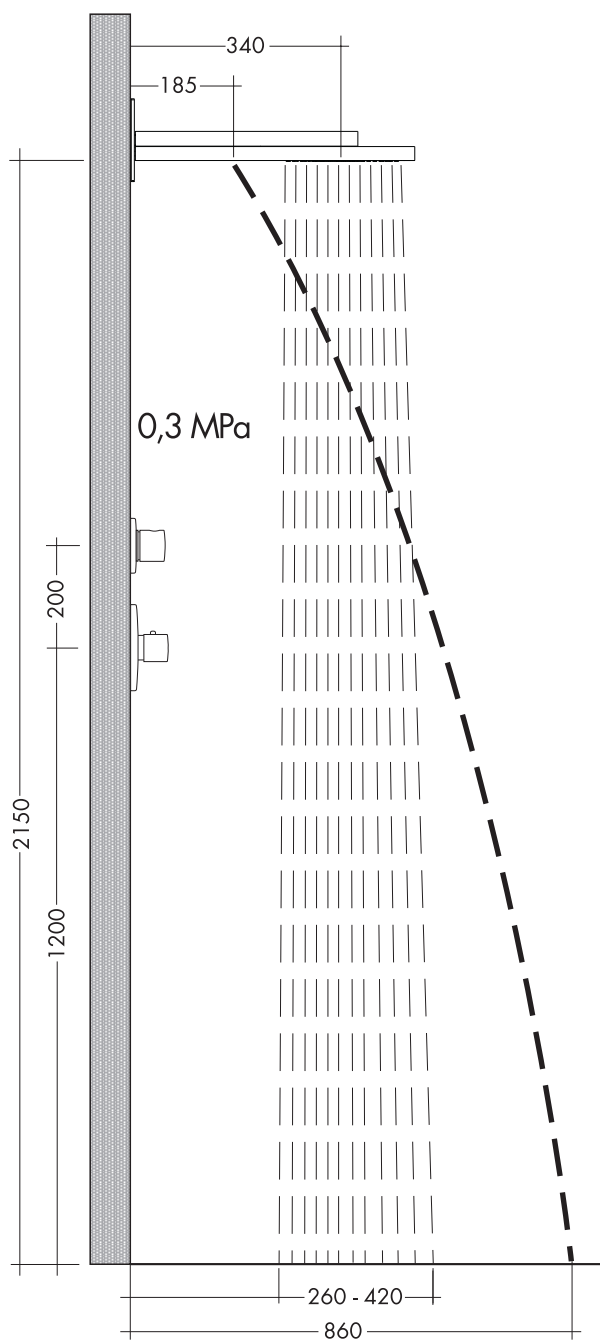
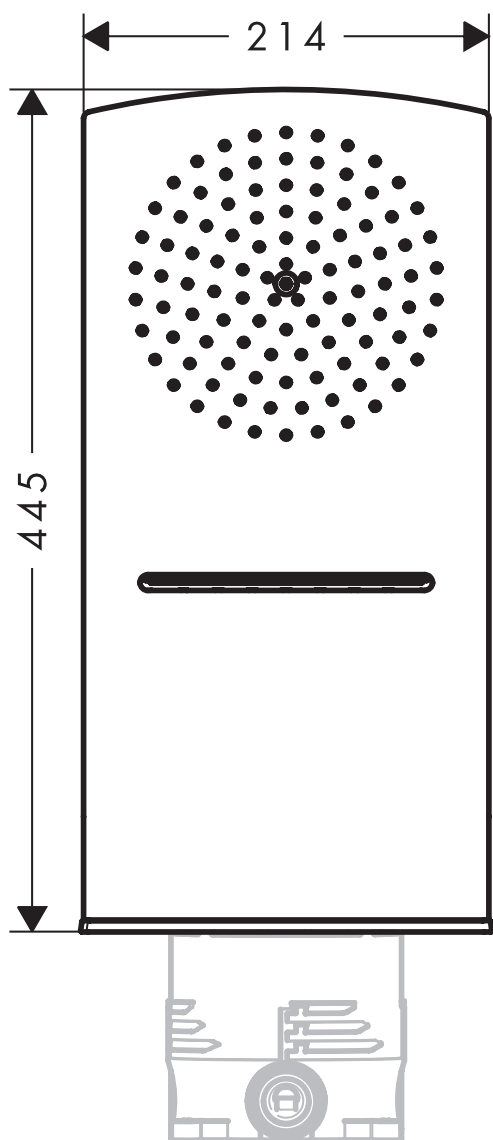
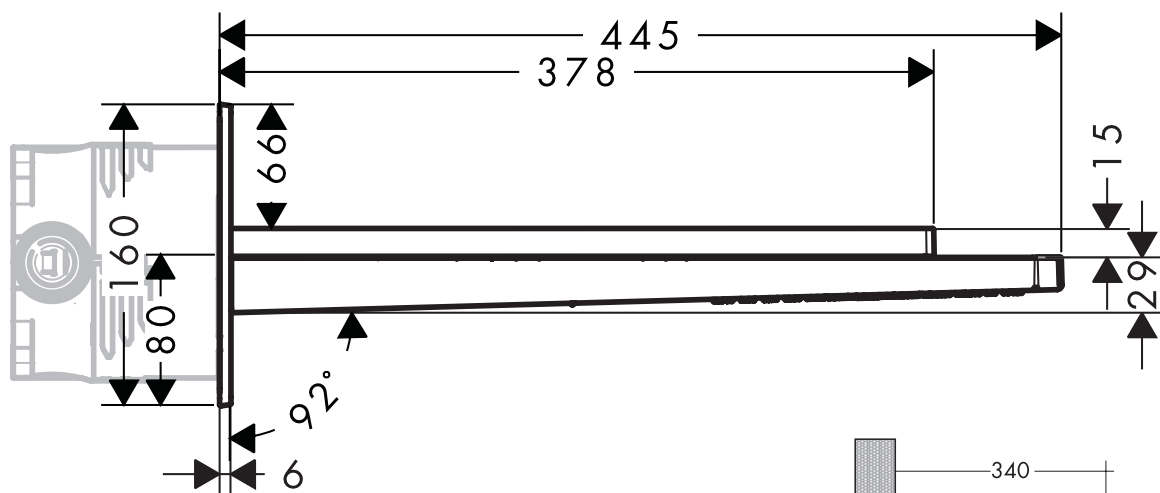

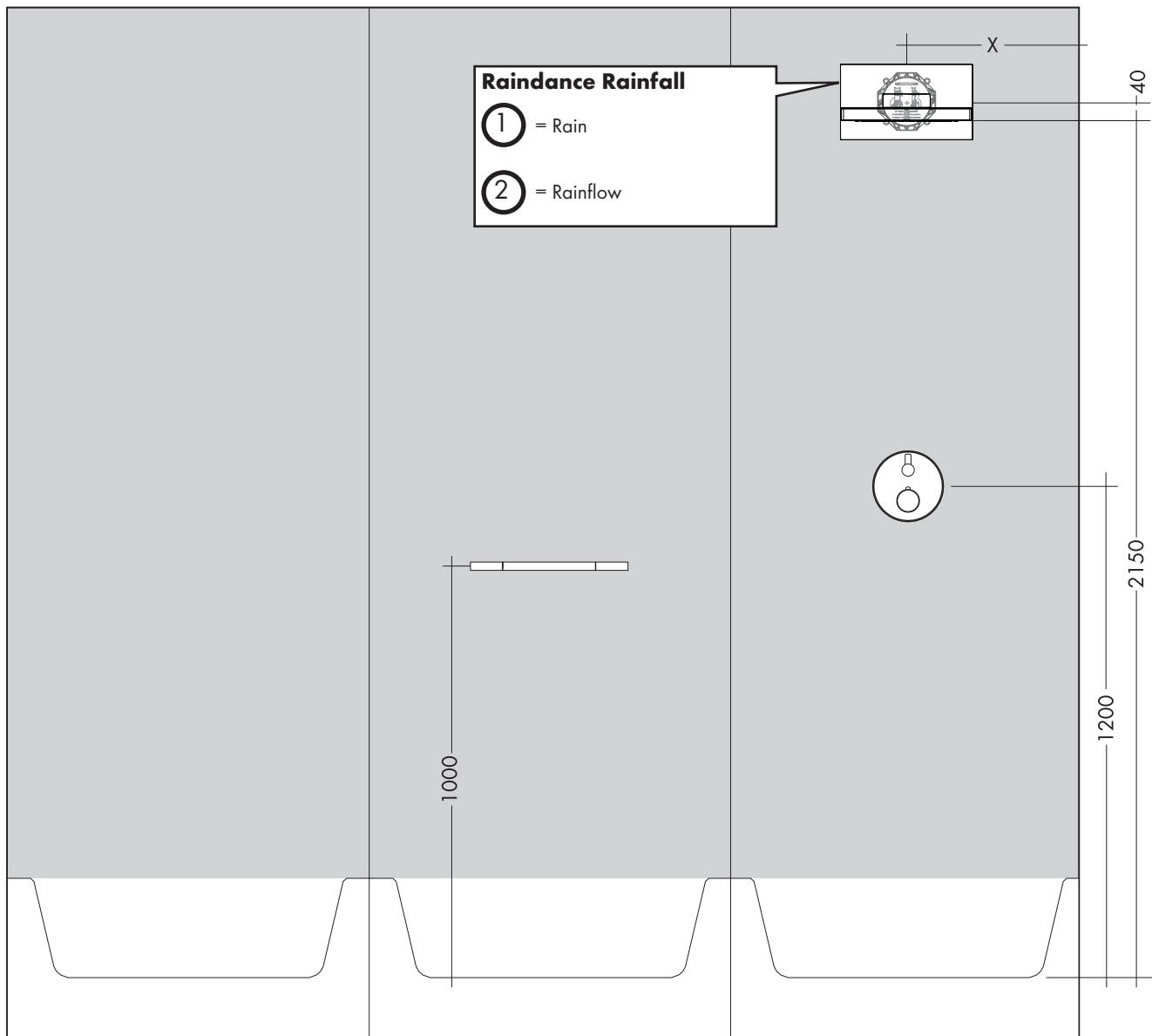
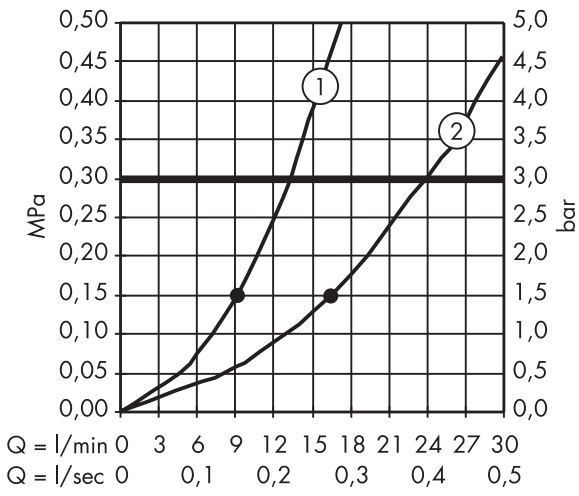

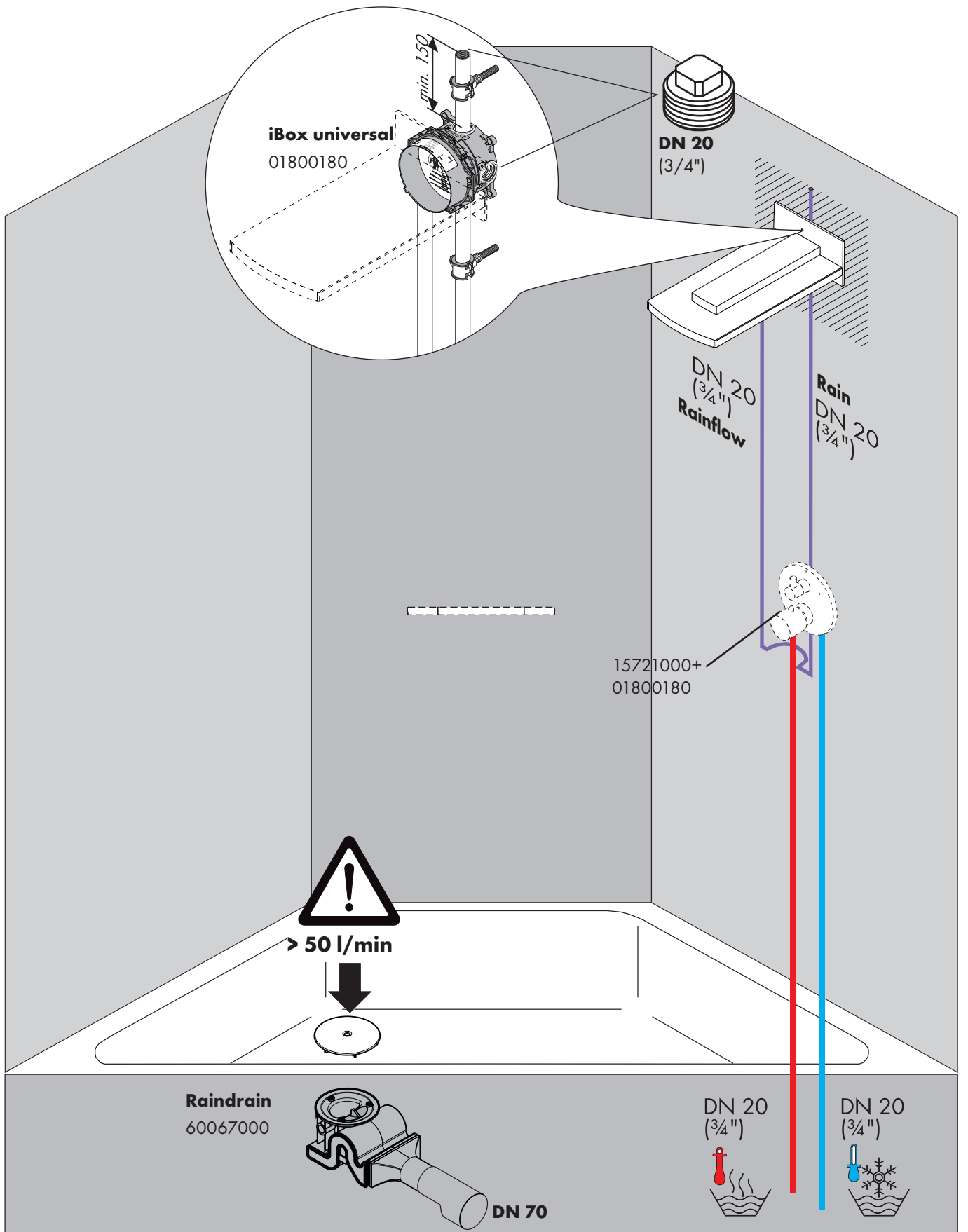

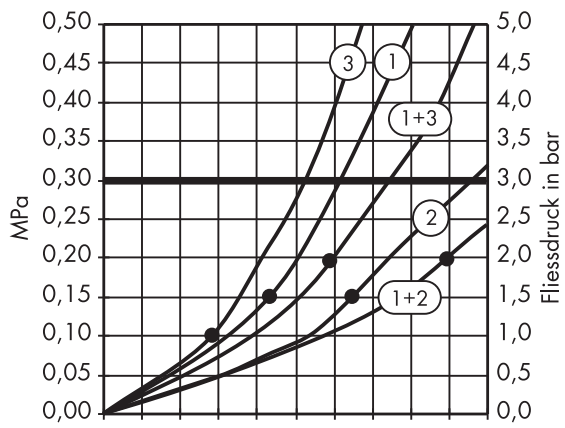

Q = l/min 0 3 6 9 12 15 18 21 24 27 30
Q = l/sec 0 0,1 0,2 0,3 0,4 0,5

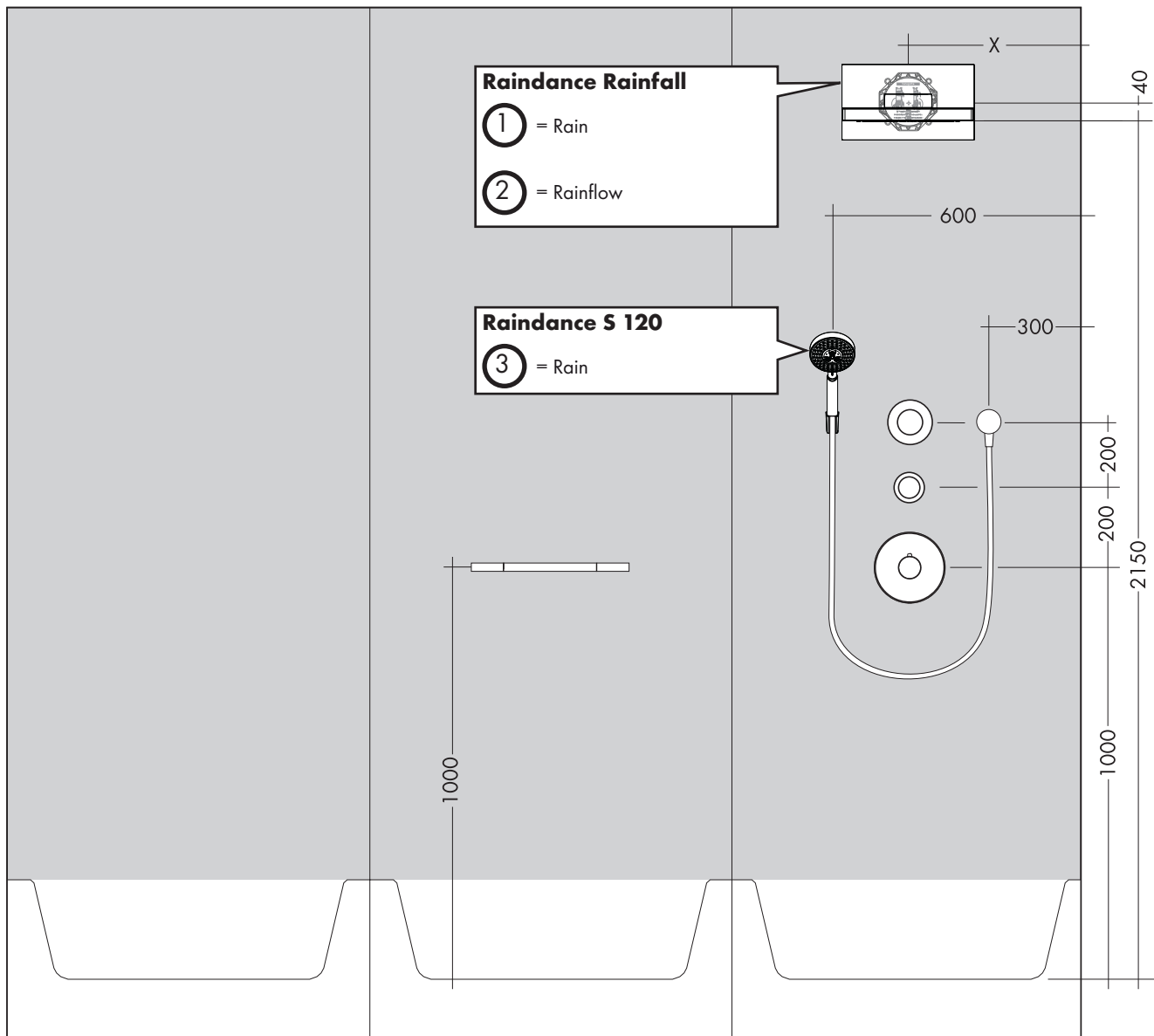

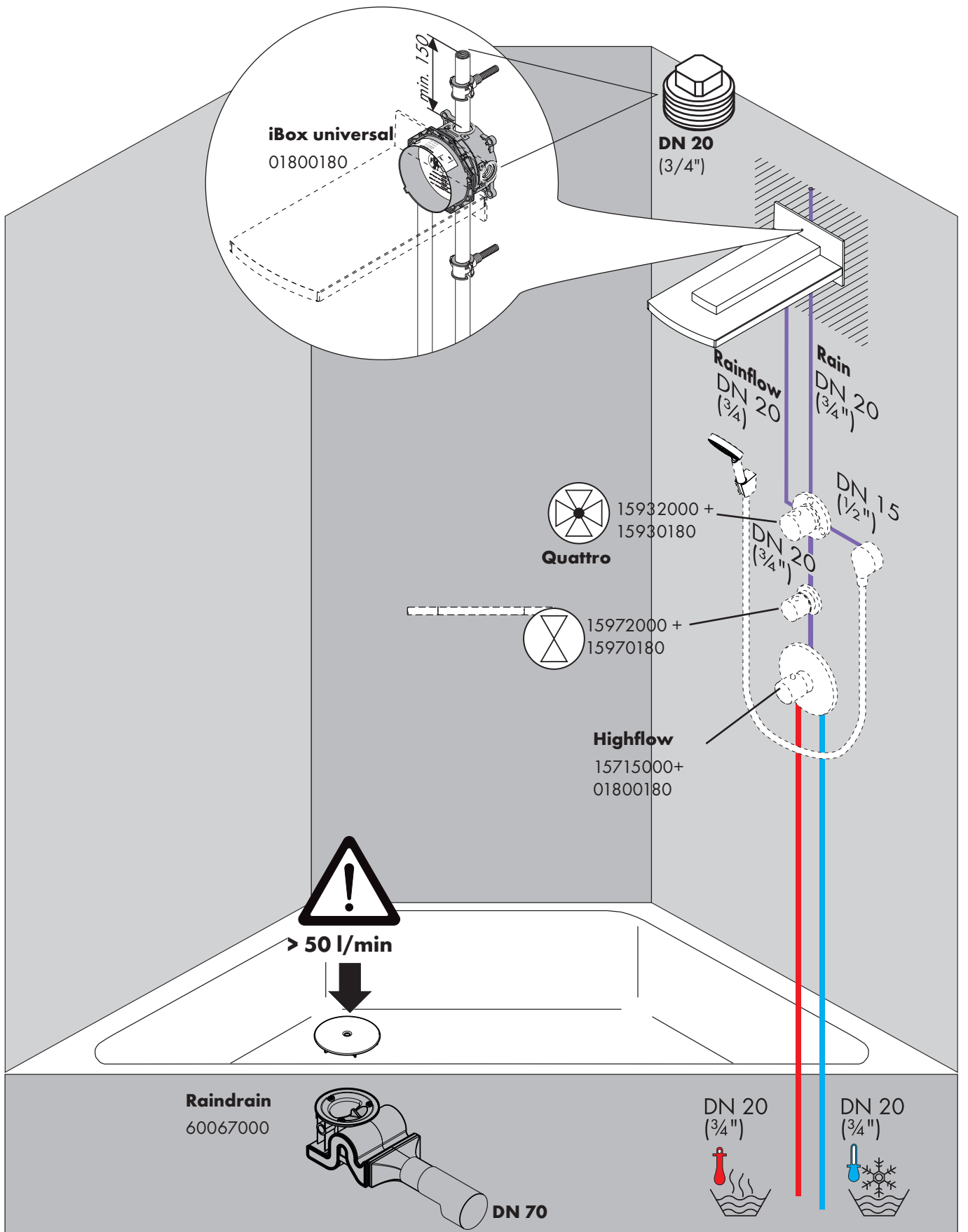

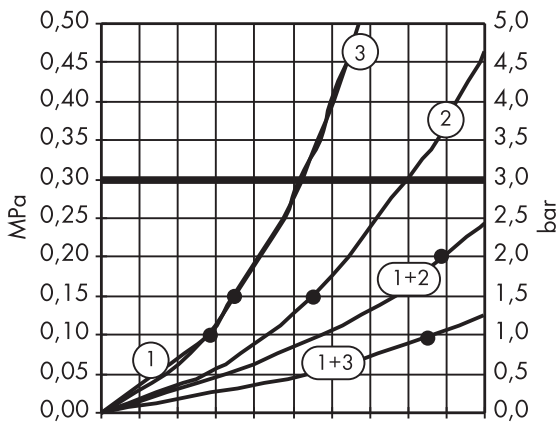

Q = l/min 0 3 6 9 12 15 18 21 24 27 30
Q = l/sec 0 0,1 0,2 0,3 0,4 0,5

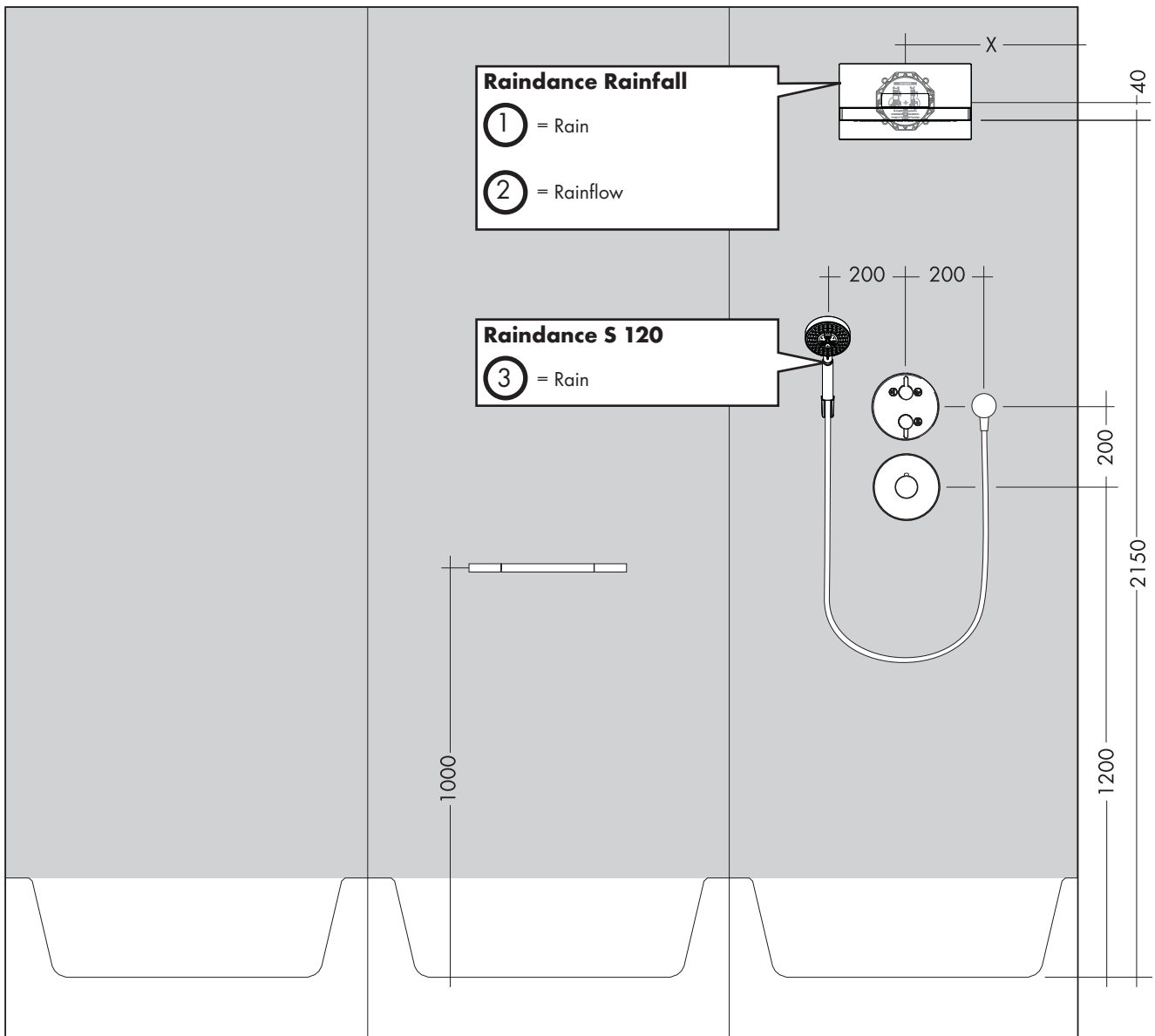

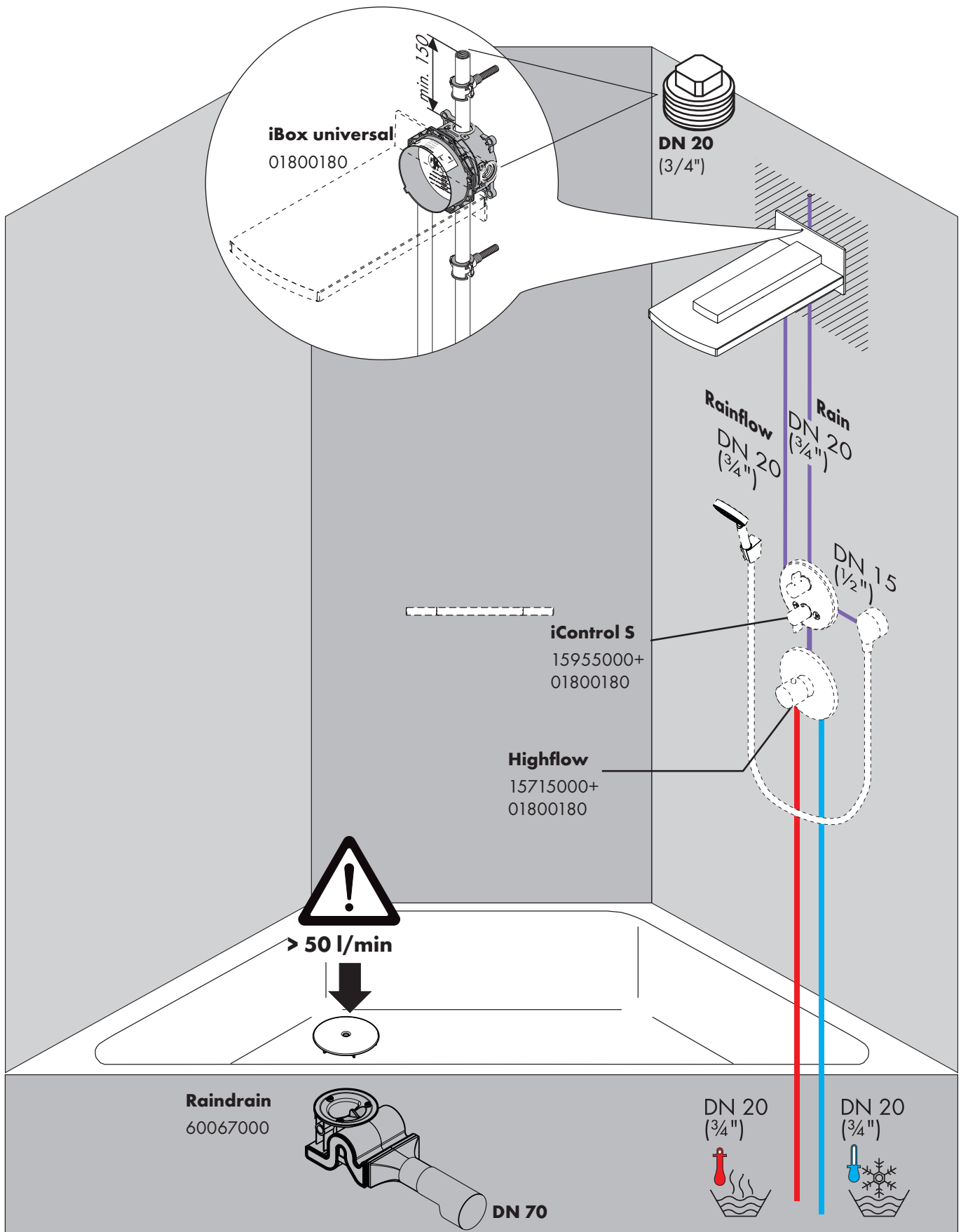

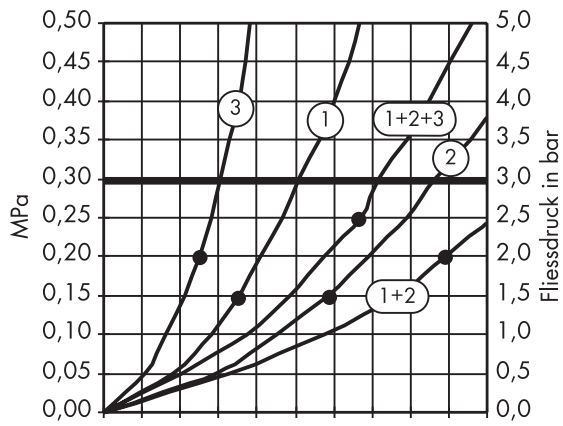

Q = l/min 0 3 6 9 12 15 18 21 24 27 30
Q = l/sec 0 0,1 0,2 0,3 0,4 0,5

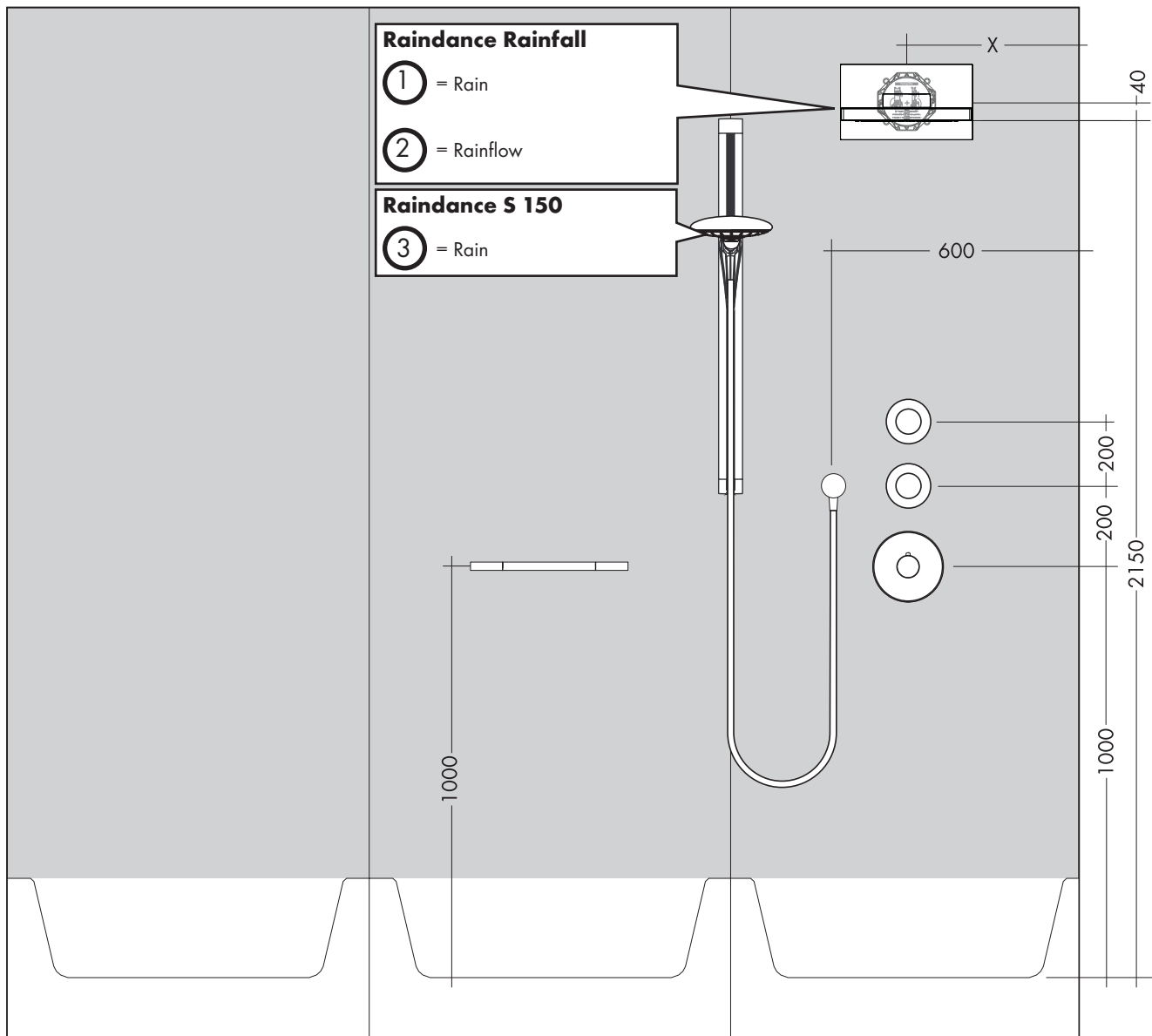

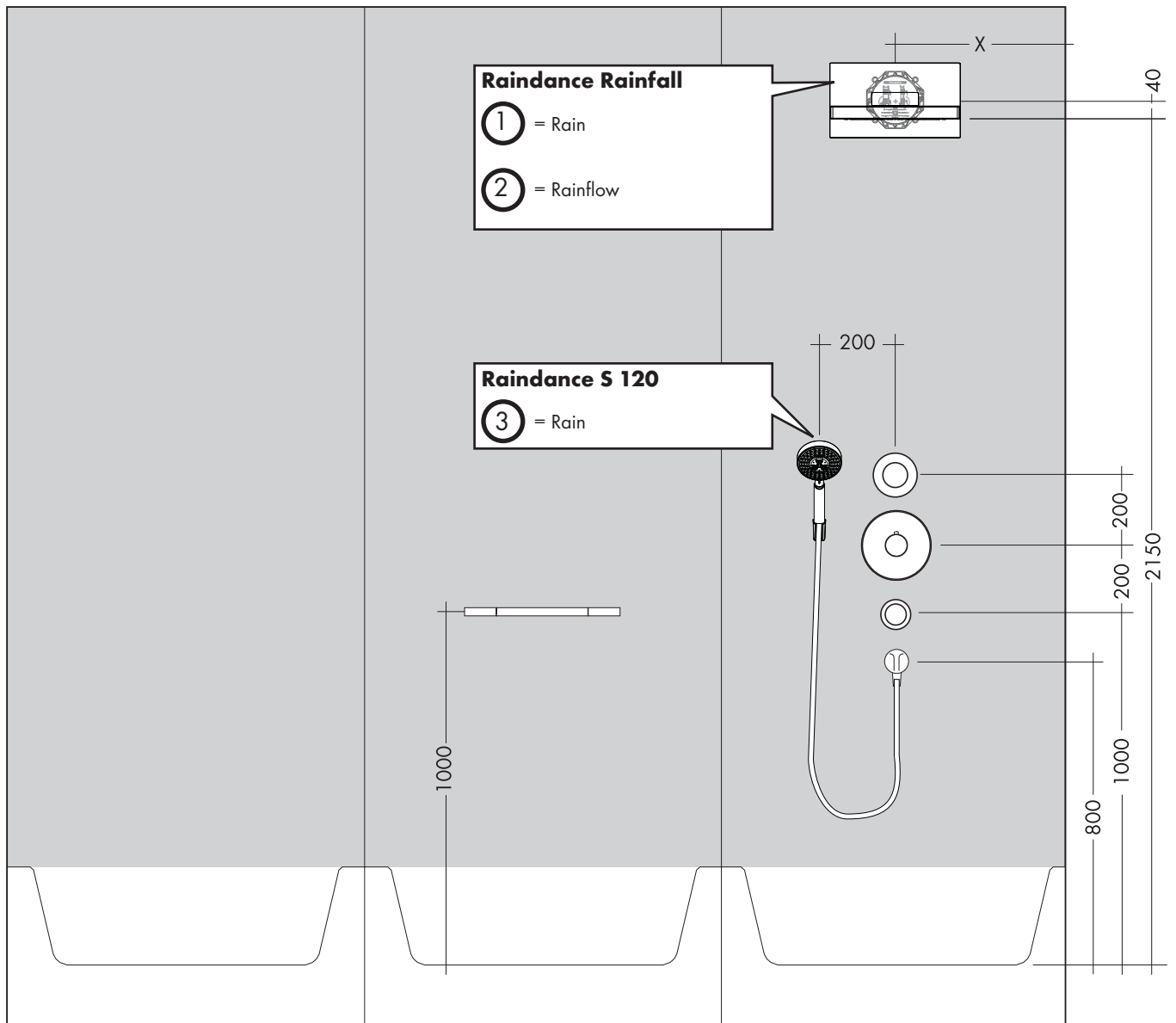
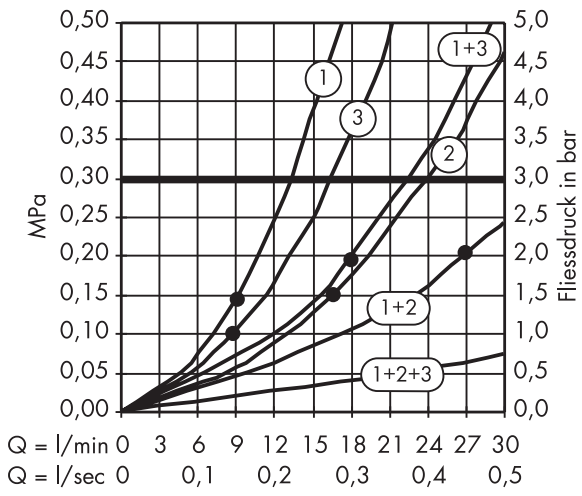

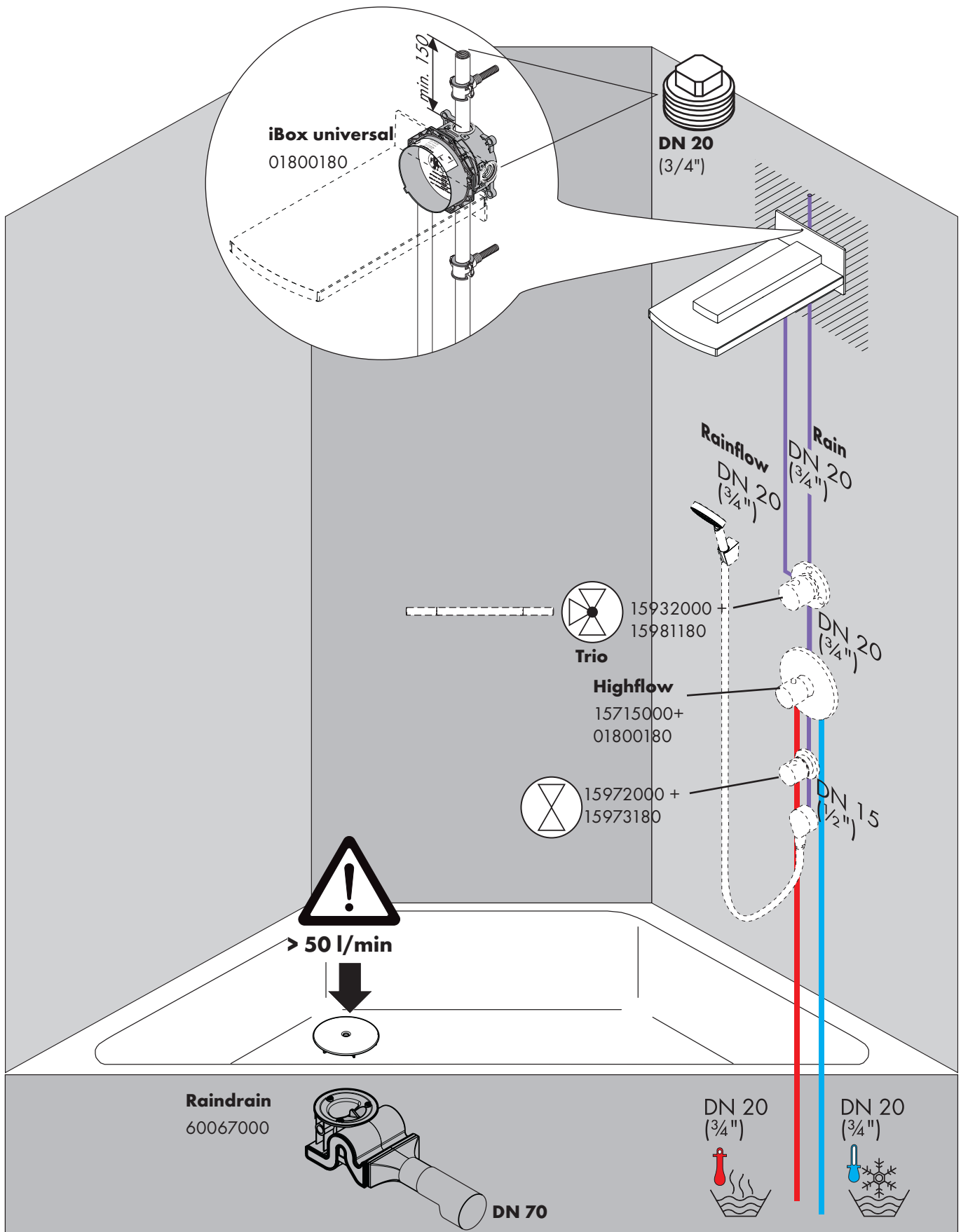

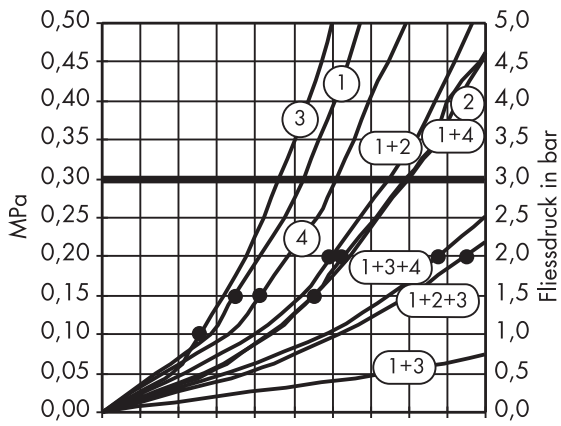

Q = l/min 0 3 6 9 12 15 18 21 24 27 30
 Q = l/sec 0 0,1 0,2 0,3 0,4 0,5

