

# Installation

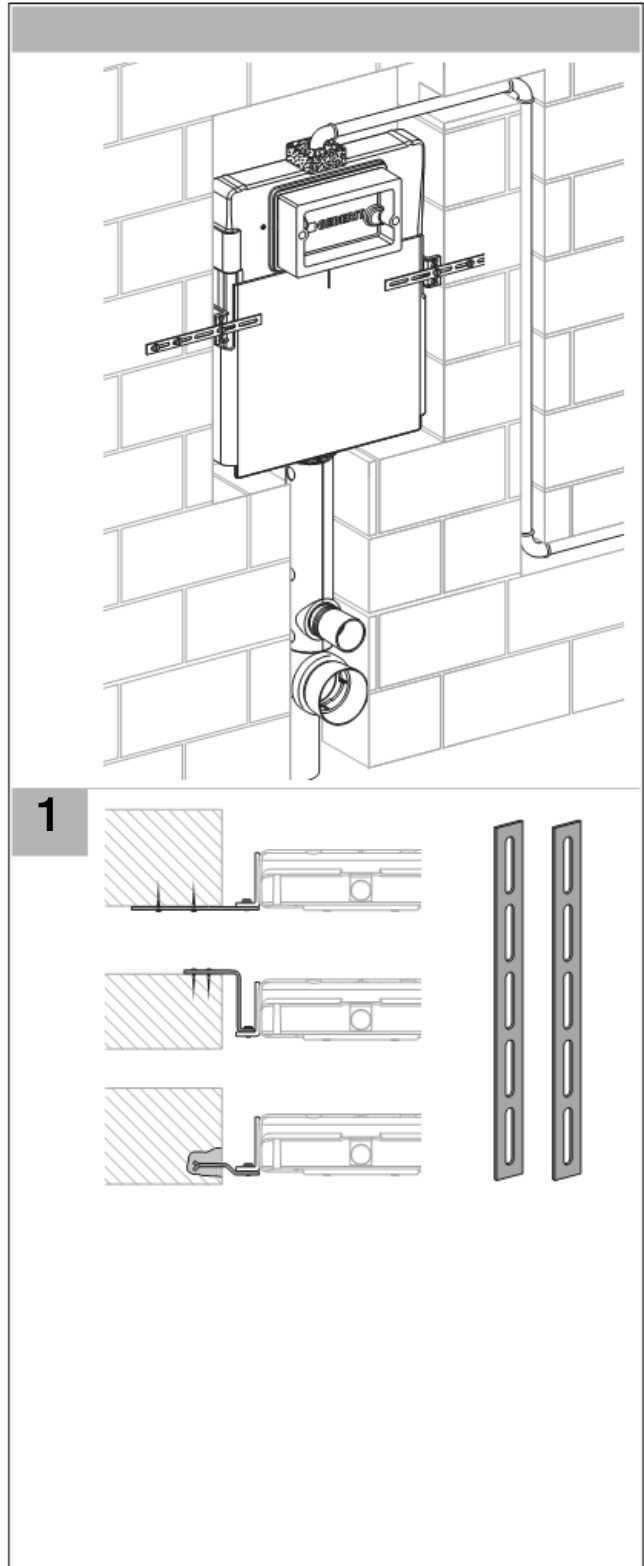

D33801-001&BDC © 12-2008

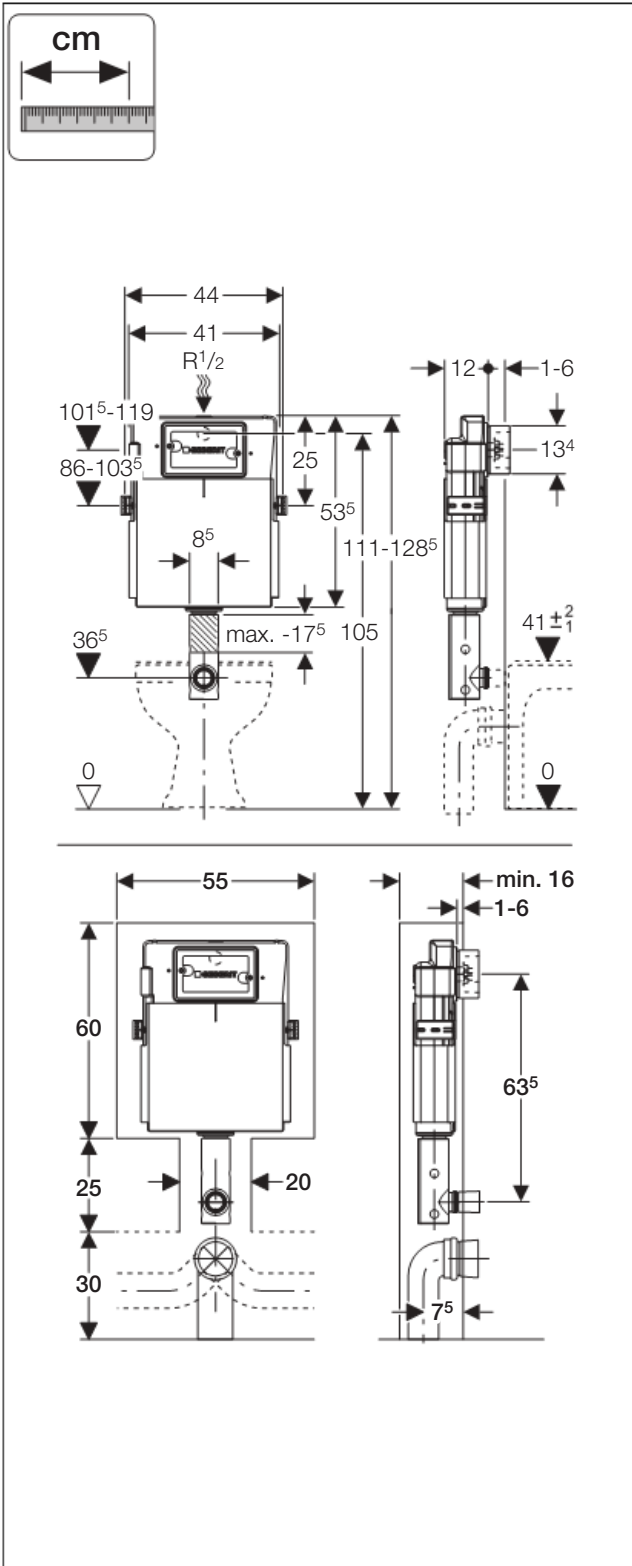

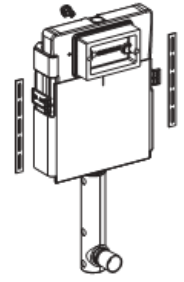
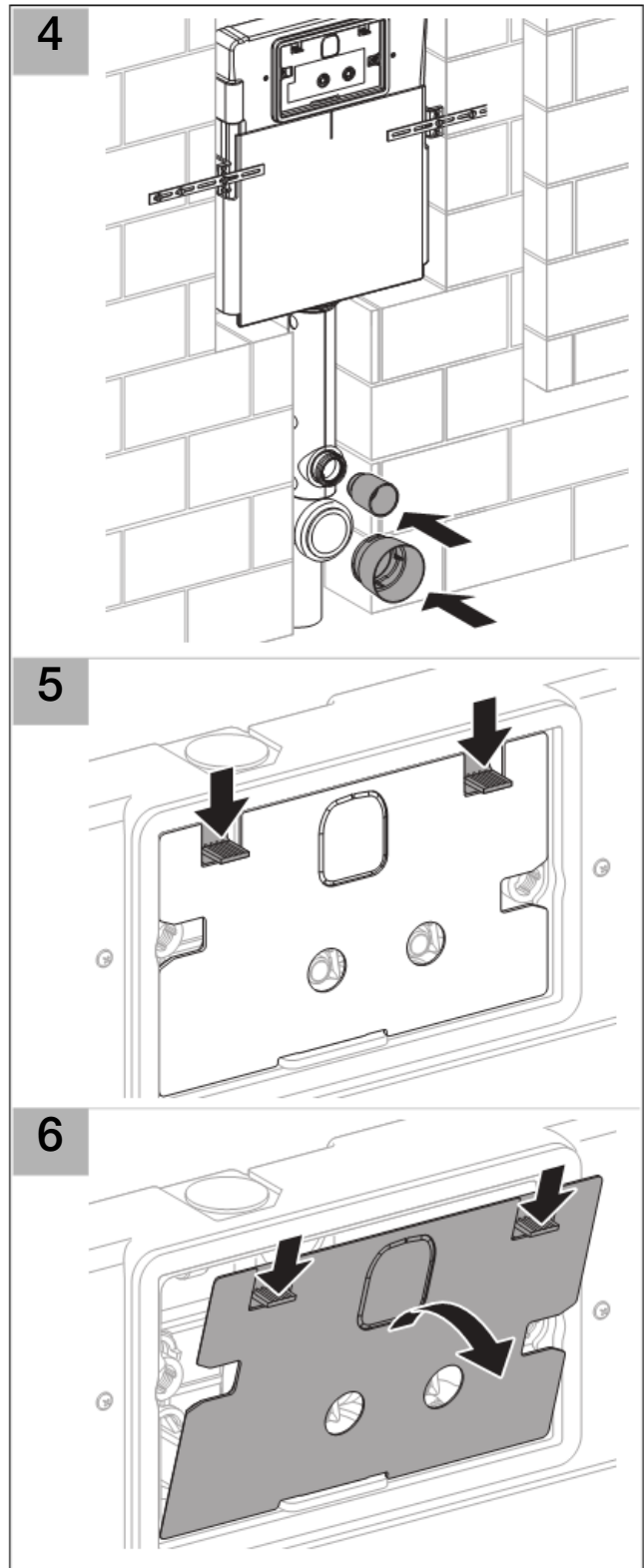
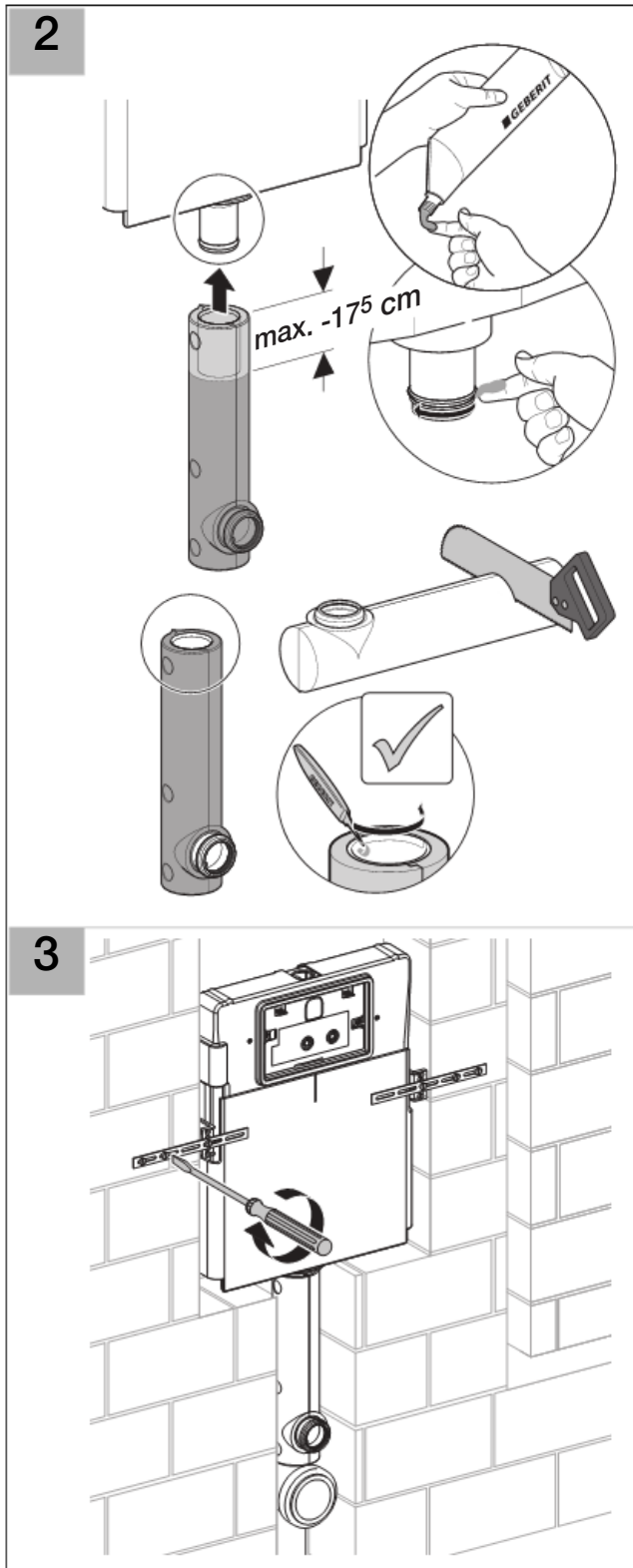
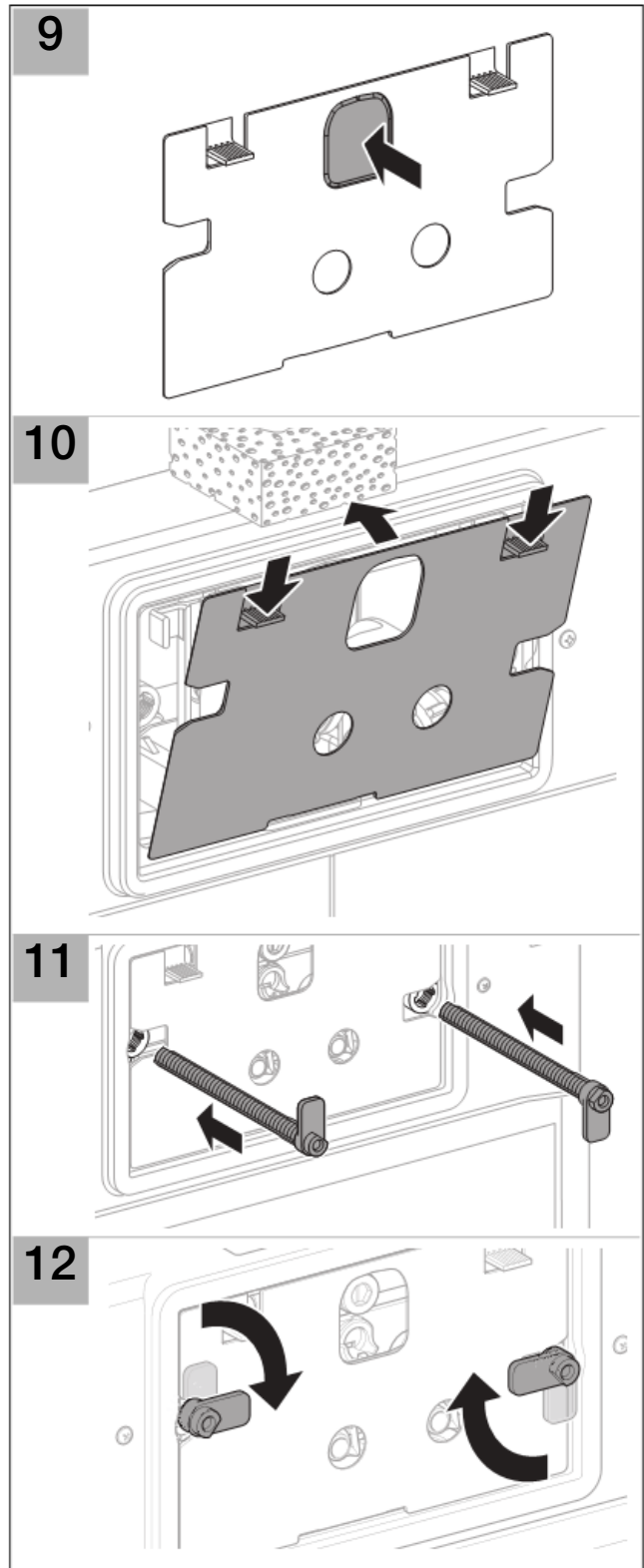
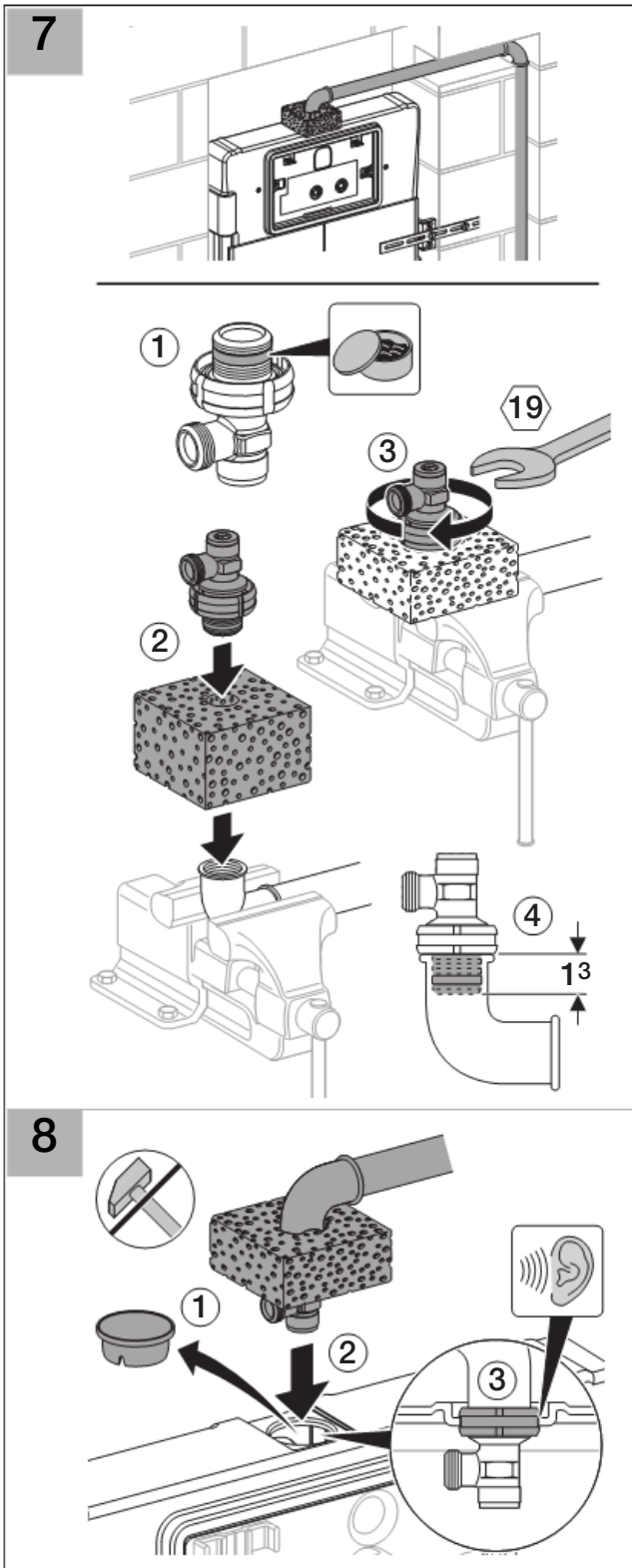

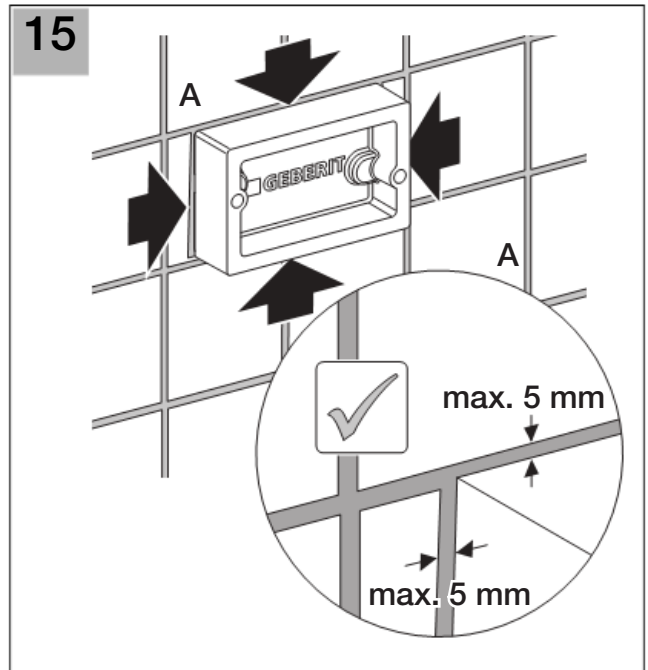
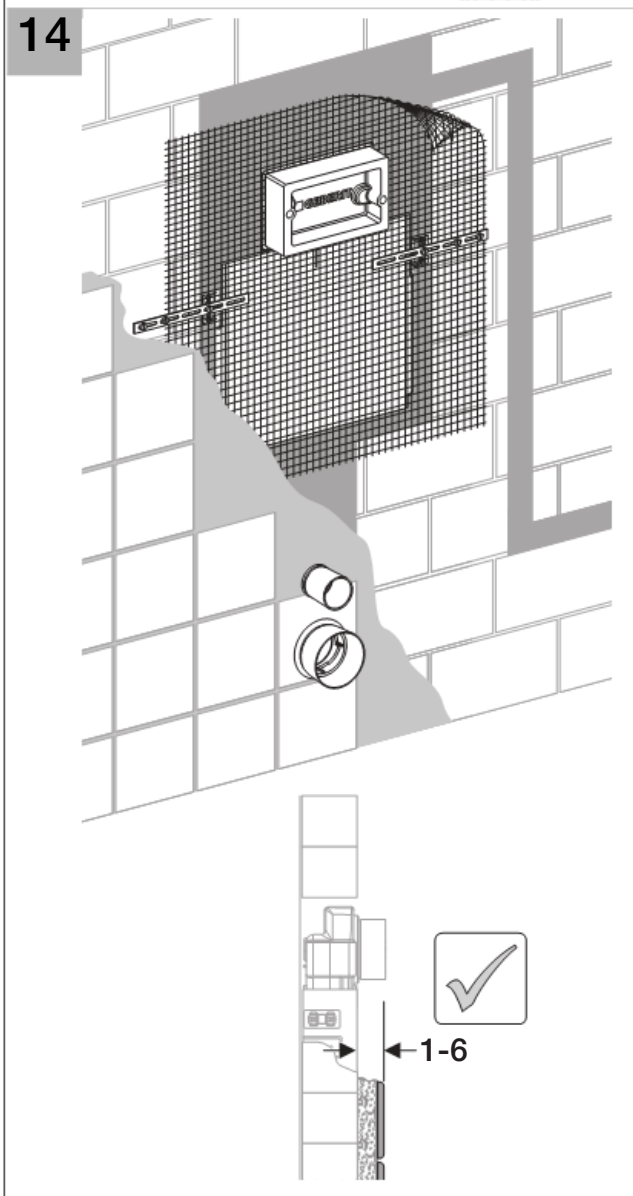
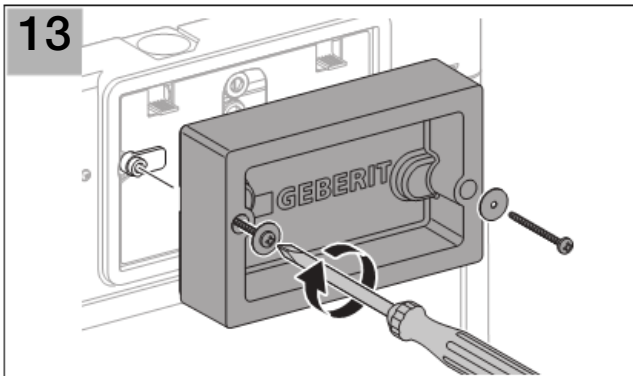

Geberit International AG  
Schachenstrasse 77  
CH-8645 Jona  
[www.geberit.com](http://www.geberit.com)  
[dokumentation@geberit.com](mailto:dokumentation@geberit.com)

D33801-001&BDC © 12-2008